



updated on march 20th, 2025



perpedes FOOT ORTHOSES & ACCESSORIES



CLIENT NUMBER AT HAND?

---

The Perpedes foot orthotic blanks listed below are not medical products in the sense of the Medical Device Regulation (MDR). They only achieve their final medical purpose after further processing by qualified personnel. The HMV-compliant properties listed in detail therefore only serve as an aid to selecting a suitable foot orthotic blank.





## PERPEDES

People and their locomotion are central to Perpedes. Our innovative products in the foot orthotic, therapeutic shoes and leg orthoses segments contribute to increasing mobility and promoting health. These increase well-being and quality of life.

Good ideas need a partner who thinks and acts practically and economically. A partner who gives your thoughts shape and makes the success perfect.

Our successful approach lies in the synergy of craftsmanship and high technology. We have a highly qualified team which is full of ideas and supports you with a forward-looking production concept.

Working closely with physicians and orthopedic technicians, products and materials have been created since 1923 which set new industry standards.

[www.perpedes.com](http://www.perpedes.com)

# TABLE OF CONTENTS

About Perpedes .....	8	Worker <sup>2</sup> Pro HAIX® .....	96	<b>MATERIALS</b> .....	<b>171</b>
Ordering at Perpedes .....	10	Worker <sup>2</sup> Calca HAIX® .....	98	TOP COVERS .....	173
Service / That's what sets us apart .....	11	Worker <sup>2</sup> CPX HAIX® .....	100	Clarino Nash .....	174
<b>Perpedes 4YOU</b> .....	<b>13</b>	Worker <sup>2</sup> Pro ATLAS .....	102	DryFeet Smooth .....	175
Foot Orthoses .....	14	Worker <sup>2</sup> Calca ATLAS .....	104	DryFeet Finely perforated .....	176
Fiber Composite Sheets .....	16	Worker <sup>2</sup> CPX ATLAS .....	106	DryFeet Microperforated .....	177
Textile an cushioning materials .....	17	Worker <sup>2</sup> Pro STEITZ SECURA .....	108	DryFeet Eucalyptus .....	178
Individual printing an labeling .....	18	Worker <sup>2</sup> Calca STEITZ SECURA .....	110	Nettex <sup>2</sup> .....	179
Individual shapes .....	19	Worker <sup>2</sup> CPX STEITZ SECURA .....	112	NubuTex .....	180
<b>FOOT ORTHOSES</b> .....	<b>21</b>	<b>INJECTION MOLDING-LINE</b> .....	<b>115</b>	Perpedes PUR Nappa .....	181
SELF-SUPPORTING FOOT ORTHOSES .....	23	PP250 .....	116	Skinlife .....	182
SINGENDE-LINE .....	25	PES252 .....	118	Skinlife Printed .....	183
Singende .....	26	<b>ACCOMMODATIVE FOOT ORTHOSES</b> .....	<b>121</b>	<b>LEATHER</b> .....	<b>185</b>
Singende Easy .....	28	SOFT-LINE .....	123	Sleek Leather .....	186
<b>DAILY<sup>2</sup>-LINE</b> .....	<b>31</b>	Soft .....	124	Calfskin Leather Lining .....	186
Daily <sup>2</sup> .....	32	Soft Speedy .....	126	Cowhide Leather Lining .....	187
Daily <sup>2</sup> Flex .....	34	Soft Sport .....	128	Soft Split Cowhide Leather .....	187
Daily <sup>2</sup> Comfort+ .....	36	Soft Calca .....	130	<b>CUSHION MATERIALS</b> .....	<b>189</b>
Daily <sup>2</sup> Rigidus SE .....	38	<b>HEEL CUPPED FOOT ORTHOSES</b> .....	<b>133</b>	Perpedes EVA .....	190
Daily <sup>2</sup> Rigidus LE .....	40	FREEE!!!-LINE .....	135	Perpedes EVA Plus/Comfort .....	192
Daily <sup>2</sup> High Heel .....	42	Freee!!! Soft .....	136	EVA ESD .....	193
Daily <sup>2</sup> Control .....	44	Freee!!! Comfort .....	138	Lunairmed .....	194
Kid Control .....	46	Freee!!! Sport .....	140	Lunastik .....	194
<b>SOLEUTION-LINE</b> .....	<b>49</b>	<b>SENSOMOTORIC FOOT ORTHOSES</b> .....	<b>143</b>	Lunatec Motion .....	195
Soleution .....	50	TONUSCONTROL .....	145	PUR Memory .....	196
Soleution Support .....	52	TonusControl Concept .....	146	PUR Slow-Memory .....	197
Soleution Pro .....	54	TonusControl Support shells .....	148	Shock Absorber X .....	198
Soleution Papillon .....	56	TonusControl Accessories .....	150	PUR Medical .....	199
Soleution CPX .....	58	Sensomotoric Pads .....	152	<b>TOP LAYER COMBINATIONS</b> .....	<b>201</b>
Soleution Rigidus .....	60	<b>SELF-SUPPORTING ORTHOTIC</b>		Bi-Stretch+ .....	202
Soleution CPH .....	62	SHELLS .....	155	Clarino Nash+ .....	202
<b>CALCA-LINE</b> .....	<b>65</b>	ACRYLIC-LINE .....	157	Coolmax Lycra+ .....	203
Calca II .....	66	101 .....	158	DryFeet+ finely perforated .....	203
Calca Business .....	68	101 DET .....	158	DryFeet+ microperforated .....	204
Calca Business Dynamic .....	70	103 .....	159	EVA+ .....	206
Calca PRO X .....	72	116 .....	159	Leather+ .....	206
Calca PRO X BLUE EDITION .....	72	113 .....	160	Perpedes PUR Nappa+ .....	207
Calca PRO X XL .....	74	115 .....	160	VeloursTex+ .....	207
Calca PRO XLE .....	76	112 .....	161	ELTEN ESD Pro .....	208
Calca PRO XLE BLUE EDITION .....	76	114 .....	161	HAIX® CO System .....	208
Calca PRO X CONTROL .....	78	108 .....	162	ATLAS KLIMA-KOMFORT® .....	209
<b>WORKER<sup>2</sup>-LINE</b> .....	<b>81</b>	109 .....	162	Steitz Secura ERGO-SOFT .....	209
Worker <sup>2</sup> Pro .....	82	110 .....	163	<b>BASE/BOTTOM COVERS</b> .....	<b>211</b>
Worker <sup>2</sup> Calca .....	84	<b>SHOE/INSOLE STIFFENERS</b> .....	<b>165</b>	CarboTec .....	212
Worker <sup>2</sup> CPX .....	86	179 .....	168	Perpedes PUR Carbon .....	212
Worker <sup>2</sup> Rigidus .....	88	180 .....	168	PUR .....	213
Worker <sup>2</sup> Pro ELTEN .....	90	181 .....	169	TPU .....	213
Worker <sup>2</sup> Calca ELTEN .....	92			Vildona Nonwovens Fleece .....	214
Worker <sup>2</sup> CPX ELTEN .....	94			Nonwoven Fleece .....	214
				Fleece Tex .....	215

CORK .....	217
Thermo cork .....	218
<b>ACRYLIC FIBER COMPOSITE</b>	
<b>SHEETS .....</b>	<b>221</b>
Knitted glass fiber .....	222
G421 .....	222
G431 .....	222
Knitted glass fiber/Knitted polyamide	
with embedded stitch yarns .....	222
G422 .....	222
G422+ .....	222
GPH441 .....	222
GPH451 .....	222
Knitted glass fiber/Knitted polyamide	223
GH501 .....	223
GH502 .....	223
GH503 .....	223
HGH531 .....	223
Woven glass fiber/Knitted	
polyamide .....	223
GH701 .....	223
GH702 .....	223
BF7001 .....	223
BF7002 .....	223
BF7003 .....	223
Knitted carbon fiber .....	224
C601 .....	224
C602 .....	224
C603 .....	224
Knitted carbon fiber/Knitted	
polyamide .....	224
C501 .....	224
C502 .....	224
C511 .....	224
C521 .....	224
C101 .....	224
C102 .....	224
Woven carbon fiber/Knitted	
polyamide .....	225
C201 .....	225
C202 .....	225
C203 .....	225
C205 .....	225
C206 .....	225

Carbon fiber/Knitted polyamide .....	225
C301 .....	225
C302 .....	225
<b>ACCESSORIES .....</b>	<b>227</b>
<b>BALANCER - Heel Post Module .....</b>	<b>230</b>
<b>MET PADS .....</b>	<b>233</b>
Drop shape .....	234
Anatomic shape .....	237
Retrocapital shape .....	239
Sensomotoric pads	
for TonusControl .....	240
<b>CUSHIONS AND PADS .....</b>	<b>243</b>
Heel cushions .....	244
Comfort cushions .....	245
Silicon heel pad .....	247
<b>ASSESSMENT .....</b>	<b>249</b>
Foot Impression Foam .....	250
Podopaper .....	250
Peloprint Film .....	250
<b>GOOD TO KNOW .....</b>	<b>253</b>
Outlines .....	254
Longitudinal arch / 3D-contour .....	256
Product Selection Guide .....	258
Conversion charts .....	259
<b>Terms &amp; Conditions .....</b>	<b>260</b>

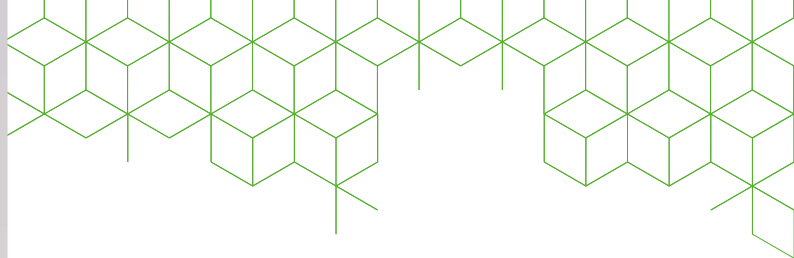

## ABOUT PERPEDES

**„Good ideas are desired by partners who think and act practically and economically. Partners who can give shape to ideas and make the success perfect.“**

The name Perpedes comes from the Latin „per pedes“ and means „on foot“. A fitting name for a company that specializes in the health of feet. After all, our feet are responsible for taking us from A to B and often they are given too little attention. They should work and carry us through life, if possible without injuries or other ailments. Nevertheless, feet are a very complex topic.

Not infrequently, we have minor deformities or injuries that we simply „tick off“ without being aware of what effects these can have on the rest of the body. Back pain, for example, can come from a malpractice while walking, which we do not even notice.

Healthy feet and the best possible healing process for injuries to the human gait belongs to our entire commitment. The development and production of trend-setting products of orthopedic technology and orthopedic footwear technology are the focus of our offer. Particularly noteworthy is the specialized development, production and processing of our own fiber composite materials. Outstanding product and material diversity, competence, service and uncompromising quality form the basis of our continued success until today.



Perpedes Röck 2003  
Lenningen/Schopfloch



Perpedes GmbH 2019  
Lenningen/Schopfloch with our new hall



Perpedes GmbH 2020  
Kirchheim/Teck



Perpedes 2019  
Partizánske, Slovakia



Perpedes Tecnoinsole, S.L. 2019  
Torrellano (Alicante), Spain

## MADE IN GERMANY

In 1945, the sole proprietorship „Helmut Roeck“ was founded by the orthopedic mechanic Helmut Roeck in Kirchheim unter Teck, Germany, with the purpose of providing orthopedic care to disabled war veterans and civilians. In 2014 the name changed from „Helmut Roeck GmbH“ to „Perpedes GmbH“.

Today, Perpedes GmbH is a medium-sized company with its headquarters in the greater Stuttgart area in Germany and branches in Slovakia and Spain. In total, the company has 180 employees worldwide. Perpedes GmbH is an ISO 9001:2015 and 13485:2016 certified company.

Perpedes GmbH sells its innovative treatment solutions worldwide to many satisfied professionals.



Stefan Prem  
CEO and Owner

Perpedes 4YOU  
Self-supporting foot orthoses  
Accommodative foot orthoses  
Heel cupped foot orthoses  
Sensomotoric foot orthoses  
Self-supporting orthotic shells  
Shoe / insole stiffeners  
Top covers  
Cushion materials  
Top layers combinations  
Base / bottom covers  
Acrylic fiber composite sheets  
Balancer / met pads  
Cushion and pads  
Assessment  
Good to know

# ORDERING AT PERPEDES

## 1. CHOOSING THE FOOT ORTHOTIC BASE

Choose your desired model, including the size, from more than 90 bestselling Perpedes insole shells or bases.



## 2. CHOOSING THE METATARSAL PAD

If required, choose from more than 20 different types of metatarsal pads, including the size. There are drop-shaped, anatomical pads and retrocapital bar available.

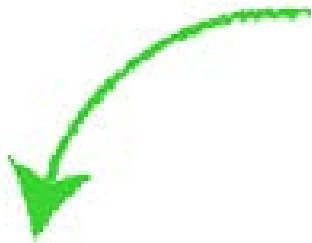

## 3. CHOOSING THE COVER MATERIAL

Choose your desired top cover from more than 80 different top cover materials. There are one layer textiles and combined covers (including EVA/PUR padding) available.

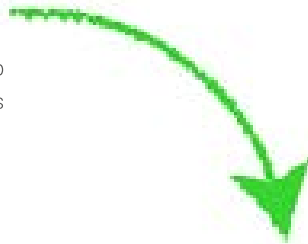

## 4. CHOOSING THE FINISHING STATUS

We can ship your foot orthotic blanks separately, partially or completely glued or finished, according to your wishes.

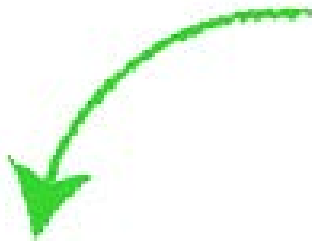

## 5. ORDERING OPTIONS

You can order on the phone or send your order to us via fax or email.

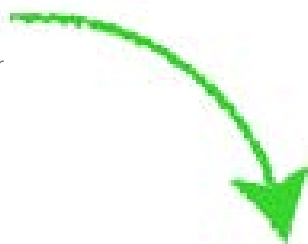

## 6. DELIVERY

You receive your foot orthotic blanks with separate modular components to be assembled in your workshop or ready-to-wear foot orthoses.

# SERVICE



## ACADEMY

The Perpedes academy offers various seminars and user workshops at the Kirchheim site. Of course, we will also gladly come to your business to carry out an on-site in-house seminar at your request. Contact us for more information!



## INDIVIDUALITY

Individuality is highly prized for us. We therefore attend to your wishes and are available to listen to your requests in Perpedes 4YOU. Whether you want to add a personal touch to your foot orthoses or implement a fiber composite sheet which has been specially designed for you, we are the competent partner with whom you can implement your ideas.



## LOGISTICS

Our bestselling foot orthotic blanks and AFOs/DAFOs are ready to be shipped within 1-2 days due to our sophisticated logistics. It does not matter whether you have placed the order for your headoffice or a subsidiary. We make sure that everything arrives at your desired address. If you should require a custom-made product or acute treatment, express and partial delivery are also available so that your workflow is not interrupted.



## ACCESSABILITY

Whether you have a question, order or request: we are always there for you. On the phone, via fax or email: we are glad to be on hand with advice and assistance. We speak English.

Order and Support:  
 Mo - Th: 8.00 am - 4.00 pm | Fr: 8.00 am - 1.00 pm  
 T. +49 (0)7021 738 30-0 | F. +49 (0)7026 738 30-298  
[info@perpedes.com](mailto:info@perpedes.com)

# THAT'S WHAT SETS US APART

## EXPERTISE

Orthopedic technology for over 75 years

## QUALITY MATERIALS

From in-house development

## CRAFT & HIGH-TECH

State-of-the-art technology & technical know-how

## BIG RANGE

The right foot orthotic blank for every treatment

## EASY ADJUSTMENT

Thanks to the flexible shell

## FREELY COMBINABLE

Various textiles and cushion materials

Perpedes 4YOU  
 Self-supporting foot orthoses  
 Accomodative foot orthoses  
 Heel cupped foot orthoses  
 Sensomotoric foot orthoses  
 Self-supporting orthotic shells  
 Shoe / insole stiffeners  
 Top covers  
 Cushion materials  
 Top layers combinations  
 Base / bottom covers  
 Acrylic fiber composite sheets  
 Balancer / met pads  
 Cushion and pads  
 Assessment  
 Good to know





## PERPEDES 4YOU

Do you have a product idea which you cannot implement due to missing resources or are you dissatisfied with products which are available on the market?

At Perpedes we are always available to listen to customers' challenges. We will gladly make our expertise available and develop a joint solution for your concrete request, until it is market-ready if desired.

Whether it be a short run or mass-production: with our state-of-the-art processing machines and sustainable operations we offer you a cost-effective platform to produce your ideas.

Speak to us: your ideas are our motivation!



OVER  
**20**  
DIFFERENT MET PADS

## FOOT ORTHOSES

Foot orthotic blanks from Perpedes made of high-quality innovative glass or carbon fiber composite shells support the foot and relieve the joints. They form the basis for healthy walking.

With Perpedes you can adjust the orthotic blanks individually and according to your patients needs:

- > Over 90 types of foot orthotic blanks
- > More than 20 different met pads (drop shapes, anatomical shaped, or met bars)
- > Over 80 top covers (single layered textiles and top cover combinations)
- > 4 different completion stages (non glued, partially glued, completely glued, finished)
- > 100% freely combinable
- > 100% INDIVIDUAL



**4**  
COMPLETION LEVELS

# 100%

FREELY COMBINABLE

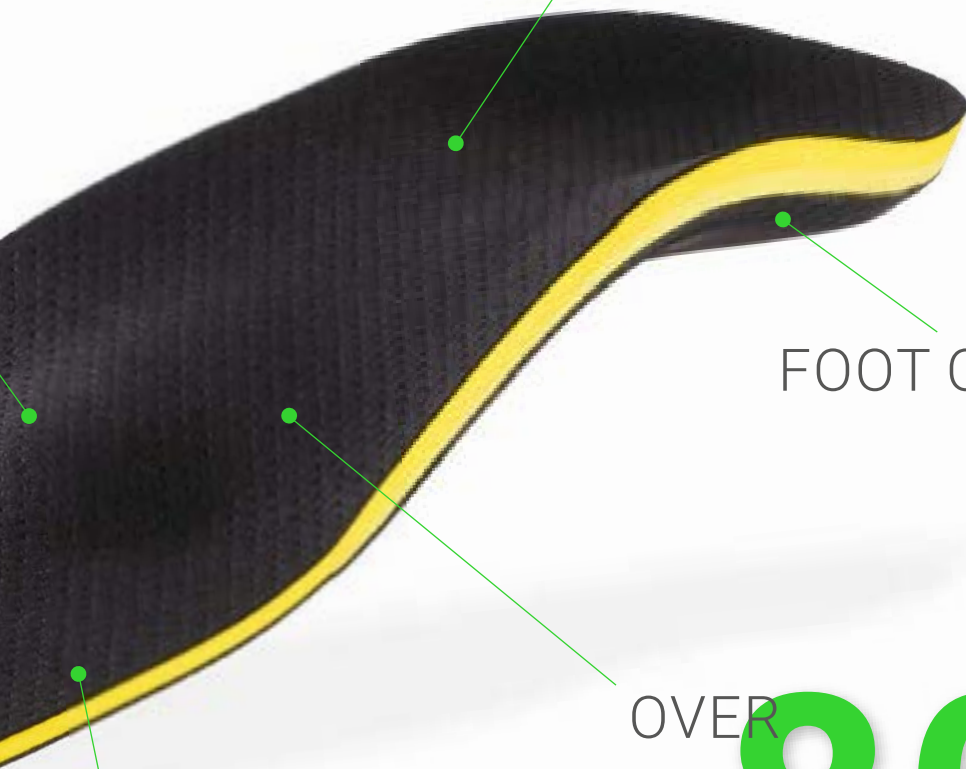

# OVER 90

FOOT ORTHOTIC BLANKS

# OVER 80

DIFFERENT TOP COVERS

# 100%

INDIVIDUAL

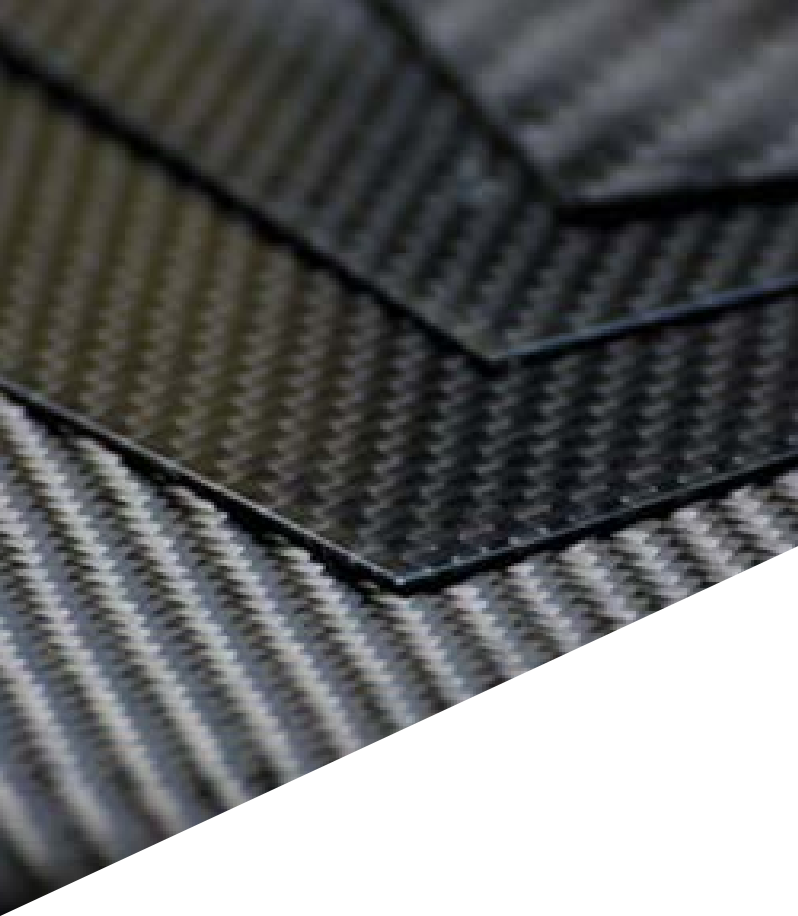

## FIBER COMPOSITE SHEETS

The product quality of the unique Perpedes composite materials made from glass and carbon fibers could be further developed and improved through decades of experience in manufacturing them.

This has yielded further applications and new variants over time so that their application in orthopedics/orthopedic shoe technology proves to be extremely variable.

At Perpedes we are always available to listen to customers' challenges. We will gladly develop a joint solution which is tailored to your needs.

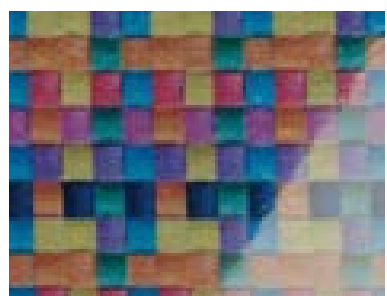
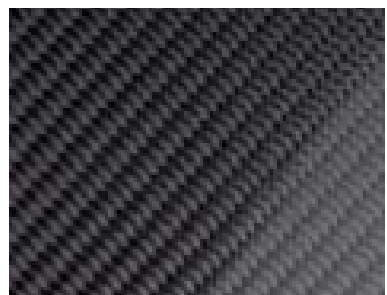
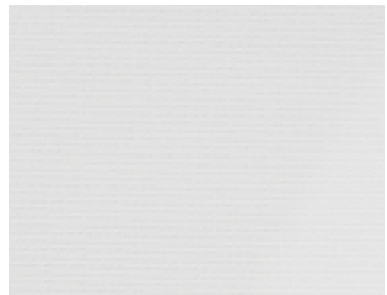



## TEXTILES AND CUSHION MATERIAL

Decisive for wearing comfort of foot orthotics is the top cover or the the cushion material.

To provide your patients with the best possible comfort and according to your ideas, we offer you the possibility to order our textiles and cushion materials pre-glued and therefore combined with each other. A real time saver in your lab.



Self-supporting  
foot orthoses



Accommodative  
foot orthoses

Heel cupped  
foot orthoses

Sensomotoric  
foot orthoses



Self-supporting  
orthotic shells

Shoe / insole  
stiffeners

Top covers



Cushion  
materials

Top layers  
combinations



Base / bottom  
covers

Acrylic  
fiber composite  
sheets

Balancer /  
met pads



Cushion  
and pads

Assessment

Good to know



## INDIVIDUAL PRINTING AND LABELING

To increase the visibility of your orthopedic appliances and to give them a personal touch, we offer the option to choose from various printing techniques for cover materials. Whether embossing, pad printing, thermal transfer labels or digital printing: We advise you on with pleasure with the conversion of your individual wishes.

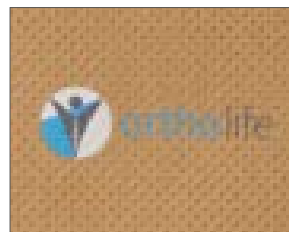

THERMAL TRANSFER PRINTING

In thermal transfer printing, a colored film label is heated. The ink layer of the film melts and transfers the motive precisely onto the top cover's surface.

Maximum color quantities for logo: unlimited

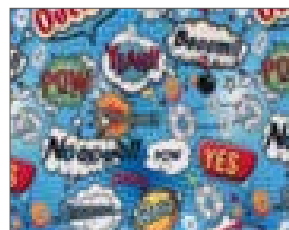

CUSTOM PRINTING (PATTERN REPEAT)

In digital printing, the image is printed directly onto the top cover textile.

Your individual logo, or motive with endless color options (pattern repeat)



EMBOSSSED LABELING

With embossed printing, the desired motive is printed and embossed on the top cover material (with color or heat stamped).

Maximum color for logo: 1

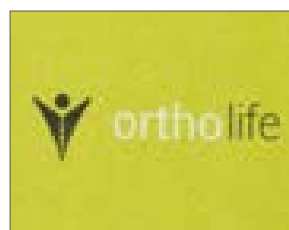

PAD PRINTING

With pad printing, the printing motive is etched to a print plate or cliché. A stamp pad with colored ink is pressed to the cliché and delivers the motive to the designated area of the top cover.

Maximum color quantities for logo: 2



## INDIVIDUAL SHAPES

Whether shoe stiffener, foot orthotic shell or an AFO/DAFO component:

With the help of our modern water jet cutter and textile cutters we can produce individually manufactured outlines made of textile or fiber composite materials, according to your specifications. You save time, streamline your processes and maintain consistent top quality.







# FOOT ORTHOSES



# SELF-SUPPORTING FOOT ORTHOSES





# SINGENDE

The SINGENDE line combines cost efficiency with individuality.

Ideally suited for initial care, the SINGENDE line offers the ideal entry into insole care without having to forego individuality. In comparison to the CLEVER line, with the SINGENDE line you have the option of choosing from various top covers, longitudinal arch heights and different types of pads and thus configuring your individual insole. The heart of the SINGENDE line is, as with other Perpedes orthotic blank forms, the orthotic shell made of specially developed glass fiber composite material. Thanks to its thermoplastic properties, this can be easily and quickly customized to the foot. The SINGENDE line uses high-quality materials that meet the high Perpedes quality standards and offer the possibility of being processed quickly and easily.

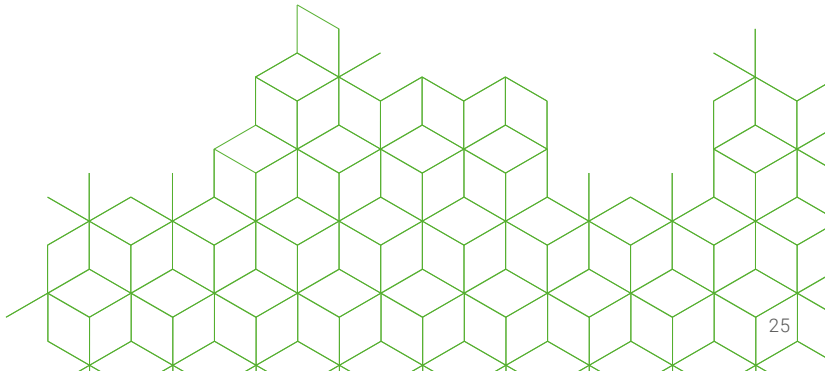

# SINGENDE

The SINGENDE orthotic blank forms the basis of the SINGENDE line. The self-supporting Perpedes glass fiber composite core with a free heel optimally supports the longitudinal arch of the foot and maintains the feeling of stepping when walking. A choice of three different longitudinal arch heights is available. Due to its thermoplastic properties, the glass fiber

composite core can be subsequently deformed and thus individually adapted to the foot and the needs of the user. Optionally, the SINGENDE can be supplemented with transverse arch support by choosing a soft, but nevertheless load-bearing pad made of carboTec material.



SINGENDE  
SIAC\_

## CHARACTERISTICS

- Supportive foot orthotic blank
- Long-sole soft cushion (optional)

## PRODUCT FACTS

Size range:	35 - 48
Width:	Narrow (35 - 44) / Medium (35 - 48)
Foot orthotic shell:	Acrylic composite material made of woven glass fiber and knitted polyamide (GH701)
Outline:	Comfort, Square, Vario
3D-Contour:	N = moderate longitudinal arch support with slightly guided heel R = higher longitudinal arch support with guided heel Z = longitudinal arch support for higher heel springs with flat heel
Special feature:	Flexible in heel area

## BESTSELLERS SINGENDE

ITEM NO. OLD	ITEM NO. NEW	BASE COVER	WIDTH	3D-CONTOUR	LENGTH	SIZE RANGE
SIC_	SIAG_	Vlies Vildona cognac	Narrow	N	3/4	35 - 44
SID_	SIAB_	Vlies Vildona cognac	Narrow	Z	3/4	35 - 44
SIE_	SIAC_	Vlies Vildona cognac	Medium	N	3/4	35 - 48
SIF_	SIAE_	Vlies Vildona cognac	Medium	Z	3/4	35 - 48
SIG_	SIAD_	Vlies Vildona cognac	Medium	R	3/4	35 - 48
	SIAH_	CarboTec black	Medium	R	3/4	35 - 48
	SIAK_	Vlies Vildona smoke	Medium	N	3/4	35 - 48

## BASE COVER

Vlies Vildona, cognac

### CHARACTERISTICS

- High abrasion resistance
- Colorfast and lightfast

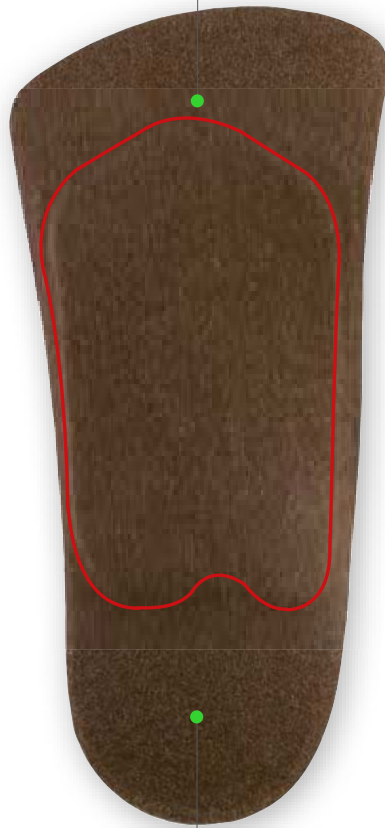

## HEEL AREA WITHOUT SHELL

Thin heel portion for a natural feeling for ground contact.

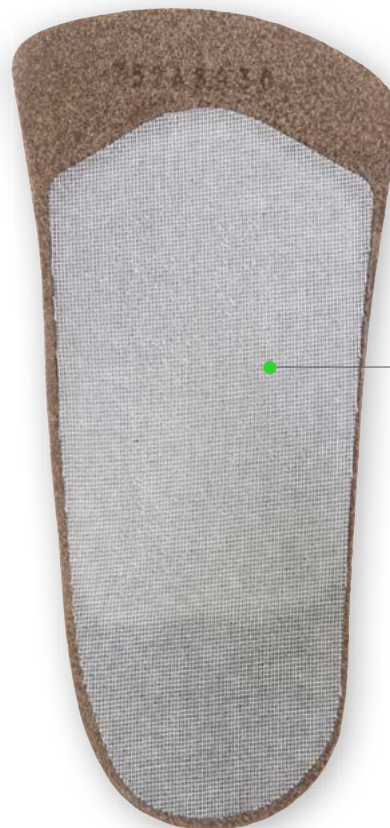

## REINFORCING LAYER

Additional reinforcing layers provide smooth transitions and dimensional stability for the orthotic blank.

# SINGENDE EASY

The SINGENDE EASY orthotic blank forms is especially suitable for users who prefer an orthotic blank with a firm heel. The self-supporting Perpedes glass fiber composite core with a firm heel optimally supports the longitudinal arch of the foot and supports the heel when walking. Due to its thermoplastic properties, the Perpedes glass fiber composite core can be subsequently deformed

and thus individually adapted to the foot and the needs of the user. Optionally, the SINGENDE EASY can be supplemented with transverse arch support by choosing a soft, yet stable pad made of carbosan material.

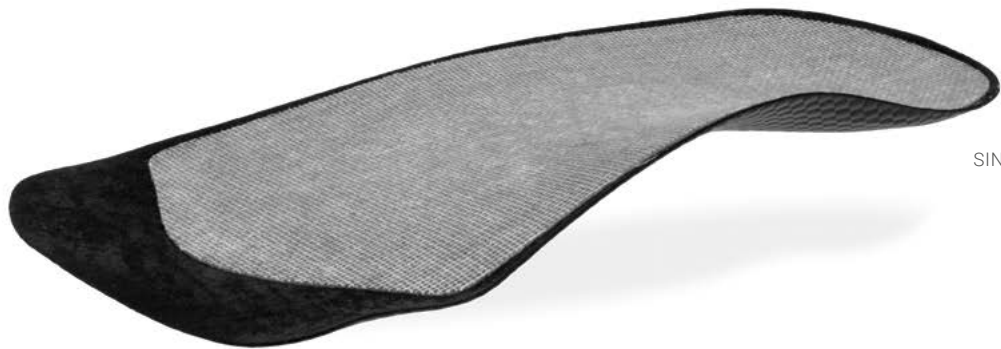

SINGENDE EASY  
SIAL

## CHARACTERISTICS

- Supportive foot orthotic blank
- Long-sole soft cushion (optional)

## PRODUCT FACTS

- Size range: 35 - 48
- Width: Narrow (35 - 44) / Medium (35 - 48)
- Foot orthotic shell: Acrylic composite material made of woven glass fiber and knitted polyamide (GH701)
- Outline: Comfort, Square, Vario
- 3D-Contour: N = moderate longitudinal arch support with slightly guided heel  
R = higher longitudinal arch support with guided heel  
Z = longitudinal arch support for higher heel springs with flat heel
- Special feature: Shell includes heel area

## BESTSELLERS SINGENDE EASY

ITEM NO. OLD	ITEM NO. NEW	BASE COVER	WIDTH	3D-CONTOUR	LENGTH	SIZE RANGE
IAA*	SIAL	PUR Carbon black	Medium	N	3/4	35 - 48

## BASE COVER

PUR, Carbon black

### CHARACTERISTICS

- Low abrasion resistance
- Colorfast and lightfast
- Slightly slip-resistant



## REINFORCING LAYER

Additional reinforcing layers with forefoot stabilizing elements provide smooth transitions and dimensional stability for the orthotic blank.

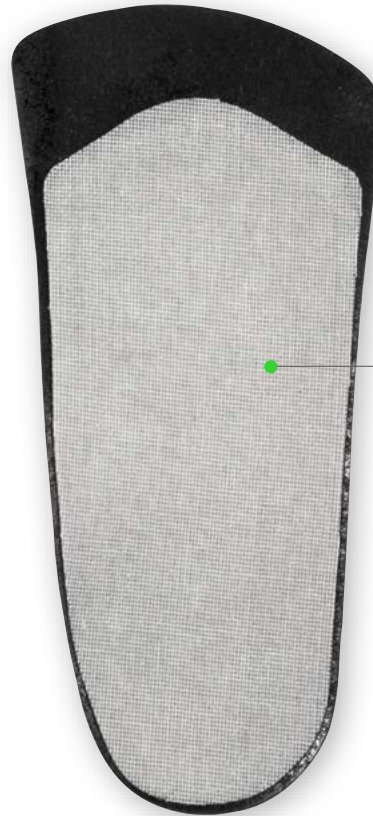





## DAILY<sup>2</sup>

The DAILY<sup>2</sup> line is most suited to use in various shoe types with low space requirements. DAILY<sup>2</sup>, DAILY<sup>2</sup> COMFORT+, DAILY<sup>2</sup> FLEX, DAILY<sup>2</sup> HIGH HEEL, DAILY<sup>2</sup> CONTROL and DAILY<sup>2</sup> RIGIDUS SE/LE are your ideal everyday companions. Designed as an extremely thin and lightweight insole, the DAILY<sup>2</sup> line gives you the opportunity to offer your customers foot orthotics which are high quality and fit inside business shoes. There are two shell widths available, narrow and medium. The DAILY<sup>2</sup> line's centrepiece is the orthotic shell made from glass fiber and carbon fiber composite material Perpedes developed and produces by itself. Due to their thermoplastic properties, these are able to adapt to the foot simply and quickly. High-quality materials which meet high demands and offer the opportunity to be quickly and easily processed.

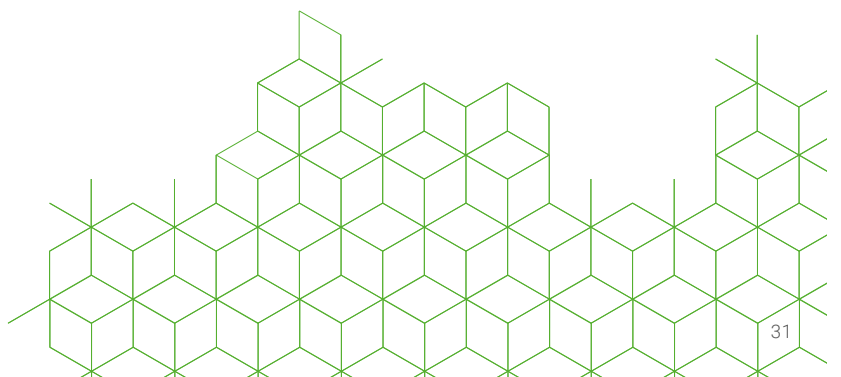

# DAILY<sup>2</sup>

The DAILY<sup>2</sup> orthotic blank forms the basis of the DAILY<sup>2</sup> line. The self-supporting but thin Perpedes glass fiber composite shell with its shell recess under the tuberosity 5th metatarsal and long wing section optimally supports the foot's longitudinal arch, guides the heel and still maintains the natural feeling when walking. The Perpedes glass fiber composite shell, which is available in two

widths, can be optionally shaped due to its thermoplastic properties and can, therefore, be uniquely adapted to the user's foot and conditions. An additional reinforcing textile layer gives the orthotic blank further stability in the forefoot area. Optionally, the DAILY<sup>2</sup> can be supplemented by soft Carbosan foam met pads which support the transversal arch.



## CHARACTERISTICS

- Supportive foot orthotic blank
- Long-sole soft cushion (optional)



Compatible with the  
**BALANCER - HEEL POST MODUL**

## PRODUCT FACTS

- Size range: 35 - 48, 49/50 - 51/52  
 Width: Narrow (35 - 44) / Medium (35 - 52)  
 Foot orthotic shell: Acrylic composite material made of knitted glass fiber (G431)  
 Outline: Business  
 3D-Contour: DA = moderate longitudinal arch support with slightly guided heel  
 Special feature: Long rear wings  
 Available with or without reinforcement under the tuberosity 5th metatarsal

## BESTSELLERS DAILY<sup>2</sup>

ITEM NO. OLD	ITEM NO. NEW	BASE COVER	ADDITION	WIDTH	LENGTH	SIZE RANGE
DAA_	DAAA_	CarboTec black	-	Narrow	4/4	35 - 44
DAL_	DAAL_	CarboTec titanium	-	Medium	4/4	35 - 52
DAG_	DAAG_	CarboTec black	COMFORT soft zone padding	Narrow	4/4	35 - 44
DAM_	DAAM_	CarboTec titanium	COMFORT soft zone padding	Medium	4/4	35 - 52



To the product video

### BASE/BOTTOM COVER

CarboTec, black (narrow width)  
CarboTec, titanium (medium width)

MATERIAL COMPOSITION  
50% PUR + 50% PA

- CHARACTERISTICS
- High abrasion resistance
  - Slightly slip-resistant
  - Colorfast and lightfast

### FOOT ORTHOTIC SHELL

Acrylic composite material made of knitted glass fiber (G431)

- CHARACTERISTICS
- Very good thermalplastic processing at approx. 140° C
  - Optimal support of the foot's longitudinal arch

FEATURE  
Shell recess under the tuberosity 5th metatarsal and central heel

### LONG REAR WINGS

Stabilized heel by long rear wings.

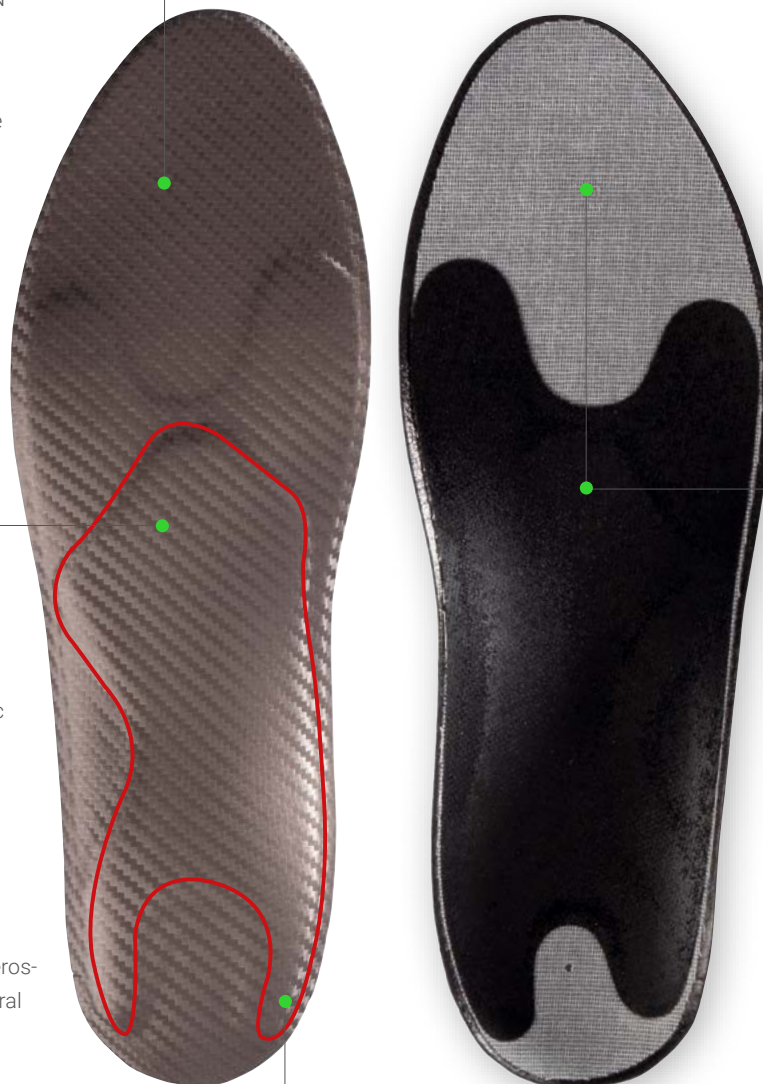

### REINFORCING LAYER

Additional reinforcing layers provide smooth transitions and dimensional stability for the orthotic blank.

# DAILY<sup>2</sup> FLEX

The DAILY<sup>2</sup> FLEX orthotic blank distinguishes itself by the dynamic, flexible heel. The extremely thin and self-supporting Perpedes glass fiber composite shell with its shell recess under the tuberosity 5th metatarsal and short wing section dynamically supports the foot's longitudinal arch and can be worn in shoes with slightly raised heels due to the flexible heel area. The glass fiber composite shell, which is available in two widths, can be optionally

shaped due to its thermoplastic properties and can, therefore, be uniquely adapted to the user's foot and requirements. An additional reinforcing textile layer gives the orthotic blank further stability in the forefoot area. Optionally, the DAILY<sup>2</sup> FLEX can be supplemented by soft Carbosan foam met pads which support the transversal arch.



## CHARACTERISTICS

- Supportive foot orthotic blank
- Long-soled soft cushion (optional)



Compatible with the  
**BALANCER - HEEL POST MODUL**

## PRODUCT FACTS

- Size range: 35 - 48, 49/50 - 51/52  
 Width: Narrow (35 - 44) / Medium (35 - 52)  
 Foot orthotic shell: Acrylic composite material made of woven glass fiber and knitted polyamide (GH701)  
 Outline: Business  
 3D-Contour: DA = moderate longitudinal arch support with slightly guided heel  
 Special feature: Short rear wings  
 Available with or without reinforcement under the tuberosity 5th metatarsal

## BESTSELLERS DAILY<sup>2</sup> FLEX

ITEM NO. OLD	ITEM NO. NEW	BASE COVER	ADDITION	WIDTH	LENGTH	SIZE RANGE
DFG_	DAFG_	Carbotec black	-	Narrow	3/4	35 - 44
DFD_	DAFD_	CarboTec titanium	-	Medium	3/4	35 - 52
DFH_	DAFH_	Carbotec black	COMFORT soft zone padding	Narrow	4/4	35 - 44
DFF_	DAFF_	Carbotec titanium	COMFORT soft zone padding	Medium	4/4	35 - 52

## BASE/BOTTOM COVER

CarboTec, black (narrow width)  
CarboTec, titanium (medium width)

MATERIAL COMPOSITION  
50% PUR + 50% PA

### CHARACTERISTICS

- High abrasion resistance
- Slightly slip-resistant
- Colorfast and lightfast

## FOOT ORTHOTIC SHELL

Acrylic composite material made of woven glass fiber and knitted polyamide (GH701)

### CHARACTERISTICS

- Very good thermalplastic processing at approx. 140° C
- Optimal support of the foot's longitudinal arch

### FEATURE

Shell recess under the tuberosity 5th metatarsal and central heel

## LONG REAR WINGS

Flexible heel by short rear wings, for improved feeling of natural gait pattern.

## REINFORCING LAYER

Additional reinforcing layers provide smooth transitions and dimensional stability for the orthotic blank.



# DAILY<sup>2</sup> COMFORT+

After further processing by orthopedic technicians the DAILY<sup>2</sup> COMFORT+ orthotic blank is ideally suited to counteract complaints in the forefoot and heel area, e.g. due to being on your feet and standing or walking longer distances. The self-supporting but thin Perpedes glass fiber composite shell with its shell recess under the tuberosity 5th metatarsal and long wing section optimally supports the foot's longitudinal arch, guides and stabilizes the heel and still maintains the natural feeling when walking. The

glass fiber composite shell, which is available in two widths, can be optionally shaped due to its thermoplastic properties and can, therefore, be uniquely adapted to the user's foot and requirements. Additional cushioning in the central forefoot and heel areas made from high-quality Shock Absorber X PUR foam reduces the painful sensation of pressure and, therefore, increases wearing comfort. Optionally, the DAILY<sup>2</sup> COMFORT+ can be supplemented by soft Carbosan foam met pads which support the transversal arch.



DAILY<sup>2</sup>COMFORT+  
DACD\_

## CHARACTERISTICS

- Supportive foot orthotic blank
- Forefoot soft cushion



Compatible with the  
**BALANCER - HEEL POST MODUL**

## PRODUCT FACTS

- Size range: 35 - 48
- Width: Narrow (35 - 44)/ Medium (35 - 52)
- Foot orthotic shell: Acrylic composite material made of knitted glass fiber (G431)
- Outline: Square
- 3D-Contour: DA = moderate longitudinal arch support with slightly guided heel
- Special feature: Forefoot and heel cushion pads made from Shock Absorber X PUR material  
Long rear wings  
Available with or without reinforcement under the tuberosity 5th metatarsal

## BESTSELLERS DAILY<sup>2</sup> COMFORT+

ITEM NO. OLD	ITEM NO. NEW	BASE COVER	ADDITION	WIDTH	LENGTH	SIZE RANGE
DCE_	DACE_	CarboTec black	-	Narrow	4/4	35 - 44
DCD_	DACD_	CarboTec titanium	-	Medium	4/4	35 - 52



To the product video

### BASE/BOTTOM COVER

CarboTec, black (narrow width)  
CarboTec, titanium (medium width)

MATERIAL COMPOSITION  
50% PUR + 50% PA

- CHARACTERISTICS
- High abrasion resistance
  - Slightly slip-resistant
  - Colorfast and lightfast

### FOOT ORTHOTIC SHELL

Acrylic composite material made of knitted glass fiber and knitted polyamide (BF7001)

- CHARACTERISTICS
- Good thermalplastic processing at approx. 140° C
  - Optimal support of the foot's longitudinal arch

#### FEATURE

Shell recess under the tuberosity 5th metatarsal and central heel

### LONG REAR WINGS

Stabilized heel by long rear wings.

### REINFORCING LAYER

Additional reinforcing layers provide smooth transitions and dimensional stability for the orthotic blank.

### FOREFOOT CUSHION PAD

Forefoot cushion pad made of yellow 7° Shore A Shock Absorber X (PUR) to relief from pressure.

### HEEL CUSHION PAD

Heel cushion pad made of yellow 7° Shore A Shock Absorber X (PUR).



# DAILY<sup>2</sup> RIGIDUS SE

After further processing by orthopedic technicians the DAILY<sup>2</sup> RIGIDUS SE orthotic blank is ideally suited for complaints in the big toe area, e.g. Hallux limitus. The self-supporting but thin Perpedes glass fiber composite shell with its shell recess under the tuberosity 5th metatarsal and short wing section dynamically supports the foot's longitudinal arch and is extended under the MTP joint 1 in such a way that the joint is spared from painful movement-related deflections whilst walking. In addition, the shell's frontal/lateral outline is lengthened, too. This ensures

a plane forefoot posture and prevents supination with all the related side effects to the knee joint. The shell's short wing heel section ensures a feeling of natural gait pattern. The glass fiber composite shell, which is available in two widths, can be optionally shaped due to its thermoplastic properties and can, therefore, be uniquely adapted to the user's foot and requirements. Additionally, the DAILY<sup>2</sup> RIGIDUS SE can be supplemented by soft Carbosan foam met pads which support the transversal arch.



DAILY<sup>2</sup> RIGIDUS  
DARS\_

## CHARACTERISTICS

- Supportive foot orthotic blank
- Rigidus splint
- Long-soled soft cushion (optional)



Compatible with the  
**BALANCER - HEEL POST MODUL**

## PRODUCT FACTS

- Size range: 35 - 48
- Width: Narrow (35 - 44) / Medium (35 - 52)
- Foot orthotic shell: Acrylic composite material made of woven glass fiber and knitted polyamide (GH702)
- Outline: Business, Square
- 3D-Contour: DR = moderate longitudinal arch support with guided heel
- Special feature: Short rear wings  
Available with or without reinforcement under the tuberosity 5th metatarsal

## BESTSELLERS DAILY<sup>2</sup> RIGIDUS SE

ITEM NO. OLD	ITEM NO. NEW	BASE COVER	ADDITION	WIDTH	OUTLINE	LENGTH	SIZE RANGE
DRQ_	DARQ_	CarboTec black	-	Narrow	Business	4/4	35 - 44
DRS_	DARS_	CarboTec titanium	-	Medium	Business	4/4	35 - 52
DRR_	DARR_	CarboTec black	COMFORT soft zone padding	Narrow	Business	4/4	35 - 44
DRT_	DART_	CarboTec titanium	COMFORT soft zone padding	Medium	Business	4/4	35 - 52



To the product video

### BASE/BOTTOM COVER

CarboTec, black (narrow width)  
CarboTec, titanium (medium width)

MATERIAL COMPOSITION  
50% PUR + 50% PA

- CHARACTERISTICS
- High abrasion resistance
  - Slightly slip-resistant
  - Colorfast and lightfast

### RIGIDUS SPLINT

Rigidus splint for motion-limiting reinforcement underneath the MTP-joint I

### FOOT ORTHOTIC SHELL

Acrylic composite material made of woven glass fiber and knitted polyamide (GH702)

- CHARACTERISTICS
- Good thermalplastic processing at approx. 140° C
  - Optimal support of the foot's longitudinal arch

### FEATURE

Shell recess under the tuberosity 5th metatarsal and central heel

### SHORT REAR WINGS

Flexible heel by short rear wings, to sustain a natural feeling for ground contact.

### REINFORCING LAYER

Additional reinforcing layers provide smooth transitions and dimensional stability for the orthotic blank.

### PROTRACTED FRONTAL/LATERAL SHELL OUTLINE

The shell's lengthened frontal/lateral outline ensures a plane forefoot posture and prevents supination with all the related negative effects to the knee joint.

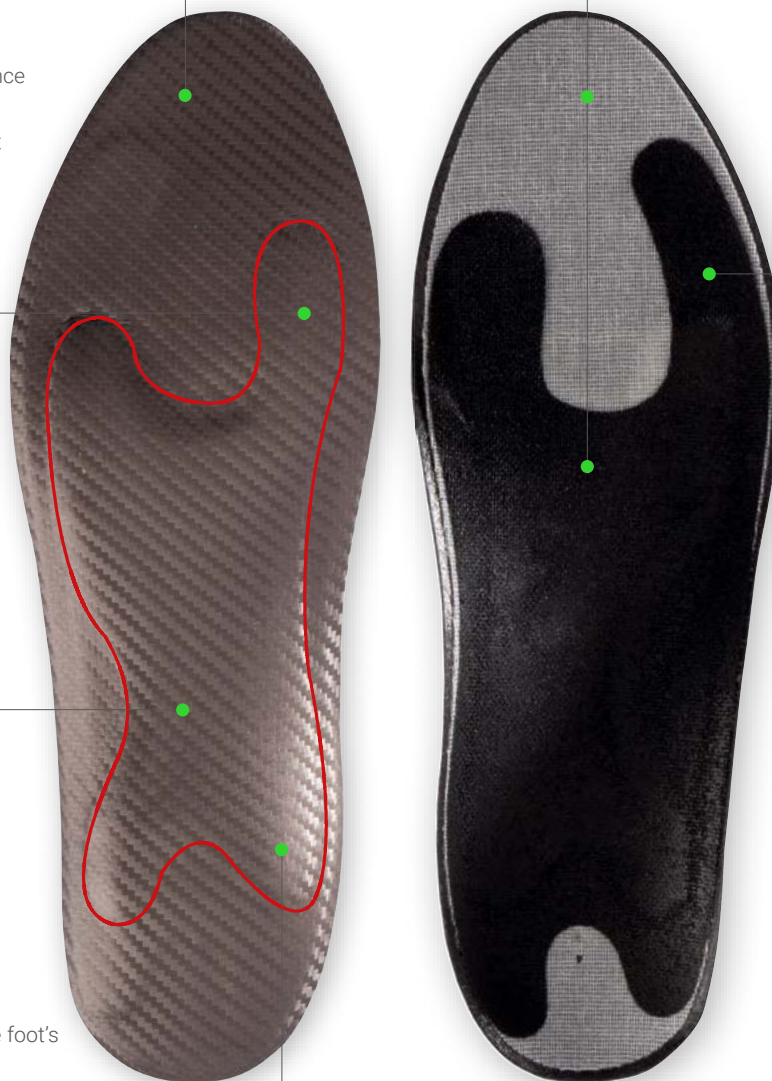

# DAILY<sup>2</sup> RIGIDUS LE

After further processing by orthopedic technicians the DAILY<sup>2</sup> RIGIDUS LE orthotic blank is ideally suited for more severe complaints in the big toe area, e.g. Hallux limitus/rigidus. The self-supporting but thin Perpedes glass fiber composite shell with its short wing section dynamically supports the foot's longitudinal arch. It is further extended under the MTP joint 1, the Hallux' DIP joint as well as the distal phalanx in such a way, that all mentioned joints are spared from the often painful movement-related deflections whilst walking. In addition, the shell's frontal/lateral outline

is lengthened, too. This ensures a plane forefoot posture and prevents supination with all the related side effects to the knee joint. The glass fiber composite shell, which is available in two widths, can be optionally shaped due to its thermoplastic properties and can, therefore, be uniquely adapted to the user's foot and conditions. Additionally, the DAILY<sup>2</sup> RIGIDUS LE can be supplemented by soft Carbosan foam met pads which support the transversal arch.



DAILY<sup>2</sup> RIGIDUS LE  
DARL\_

## CHARACTERISTICS

- Supportive foot orthotic blank
- Rigidus splint
- Long-soled soft cushion (optional)



Compatible with the  
**BALANCER - HEEL POST MODUL**

## PRODUCT FACTS

- Size range: 35 - 52
- Width: Narrow (35 - 44) / Medium (35 - 52)
- Foot orthotic shell: Acrylic composite material made of woven glass fiber and knitted polyamide (GH702)
- Outline: Business, Square, Natural outline
- 3D-Contour: DR = moderate longitudinal arch support with guided heel
- Special feature: Long rigidus extension and laterally protracted shell for a plane forefoot posture  
Short rear wings  
Available with or without reinforcement under the tuberosity 5th metatarsal

## BESTSELLERS DAILY<sup>2</sup> RIGIDUS LE

ITEM NO. OLD	ITEM NO. NEW	BASE COVER	ADDITION	WIDTH	OUTLINE	LENGTH	SIZE RANGE
DRO_	DARO_	CarboTec black	-	Narrow	Business	4/4	35 - 44
DRL_	DARL_	CarboTec titanium	-	Medium	Business	4/4	35 - 52
DRP_	DARP_	CarboTec black	COMFORT soft zone padding	Narrow	Business	4/4	35 - 44
DRM_	DARM_	CarboTec titanium	COMFORT soft zone padding	Medium	Business	4/4	35 - 52

## BASE/BOTTOM COVER

CarboTec, black (narrow width)  
CarboTec, titanium (medium width)

MATERIAL COMPOSITION  
50% PUR + 50% PA

CHARACTERISTICS

- High abrasion resistance
- Slightly slip-resistant
- Colorfast and lightfast

## LONG RIGIDUS SPLINT

Long rigidus extension is extended under the MTP joint 1, the Hallux' DIP joint as well as the distal phalanx in such a way, that these joints are spared from the often painful movement-related deflections whilst walking.

## FOOT ORTHOTIC SHELL

Acrylic composite material made of woven glass fiber and knitted polyamide (GH702)

CHARACTERISTICS

- Good thermalplastic processing at approx. 140° C
- Optimal support of the foot's longitudinal arch

### FEATURE

Shell recess under the tuberosity 5th metatarsal and central heel

## SHORT REAR WINGS

Flexible heel by short rear wings, to sustain a natural feeling for ground contact.



## PROTRACTED FRONTAL/LATERAL SHELL OUTLINE

The shell's lengthened frontal/lateral outline ensures a plane forefoot posture and prevents supination with all the related negative effects to the knee joint.

## REINFORCING LAYERS

Additional reinforcing layers provide smooth transitions and dimensional stability for the orthotic blank.

# DAILY<sup>2</sup> HIGH HEEL

After further processing by orthopedic technicians the DAILY<sup>2</sup> HIGH HEEL orthotic blank is ideally suited for use in high heeled shoes. The thin, self-supporting and highly flexible Perpedes carbon fiber composite shell with its shell recess under the tuberosity 5th metatarsal short wing section adapts optimally to the relevant shoe's heel spring. The carbon fiber shell can be optionally shaped due to its thermoplastic properties and can, therefore, be uniquely

adapted to the user's foot and requirements. Additionally, soft Carbosan forefoot and heel pads are inserted in order to reduce the specific impact sensation when wearing higher heels. Optionally, the DAILY<sup>2</sup> HIGH HEEL can be supplemented by soft Carbosan foam met pads which support the transversal arch and and is optionally available without the soft forefoot cushion pad.



## CHARACTERISTICS

- Supportive foot orthotic blank
- Long-soled soft cushion (optional)



Compatible with the  
**BALANCER - HEEL POST MODUL**

## PRODUCT FACTS

Size range: 35 - 44  
 Width: Narrow  
 Foot orthotic shell: Acrylic composite material made of knitted carbon fiber (C601)  
 Outline: Business  
 3D-Contour: DH = moderate longitudinal arch support, flat heel  
 Special feature: Forefoot and heel cushion pad made of Carbosan foam  
 Short rear wings  
 Available with or without reinforcement under the tuberosity 5th metatarsal

## BESTSELLERS DAILY<sup>2</sup> HIGH HEEL

ITEM NO. OLD	ITEM NO. NEW	BASE COVER	ADDITION	WIDTH	LENGTH	SIZE RANGE
DHB_	DAHB_	CarboTec black	-	Narrow	4/4	35 - 44
DHC_	DAHC_	CarboTec black	COMFORT soft forefoot padding	Narrow	4/4	35 - 44
	DAHA_	CarboTec black	COMFORT forefoot and heel soft zone padding	Narrow	4/4	35 - 44



To the product video

### BASE/BOTTOM COVER

CarboTec, black

MATERIAL COMPOSITION  
50% PUR + 50% PA

- CHARACTERISTICS
- High abrasion resistance
  - Slightly slip-resistant
  - Colorfast and lightfast

### FOOT ORTHOTIC SHELL

Acrylic composite material made of knitted carbon fiber (C601)

- CHARACTERISTICS
- Excellent thermalplastic processing at approx. 140° C
  - Optimal support of the foot's longitudinal arch

FEATURE  
Shell recess under the tuberosity 5th metatarsal and central heel

### SUPINATION WEDGE

By using an additional layer made from carbon fiber material (C901), the foot's arch is supported and therefore counteracts problems due to overpronation.

### SHORT REAR WINGS

Flexible heel by short rear wings, to sustain a natural feeling for ground contact.

### FOREFOOT CUSHION PAD

Forefoot cushion pad made of Carbosan foam to relief from pressure.

### REINFORCING LAYER

Additional reinforcing layers provide smooth transitions and dimensional stability for the orthotic blank..

### HEEL CUSHION PAD

Heel cushion pad made of Carbosan foam to soften impact forces.

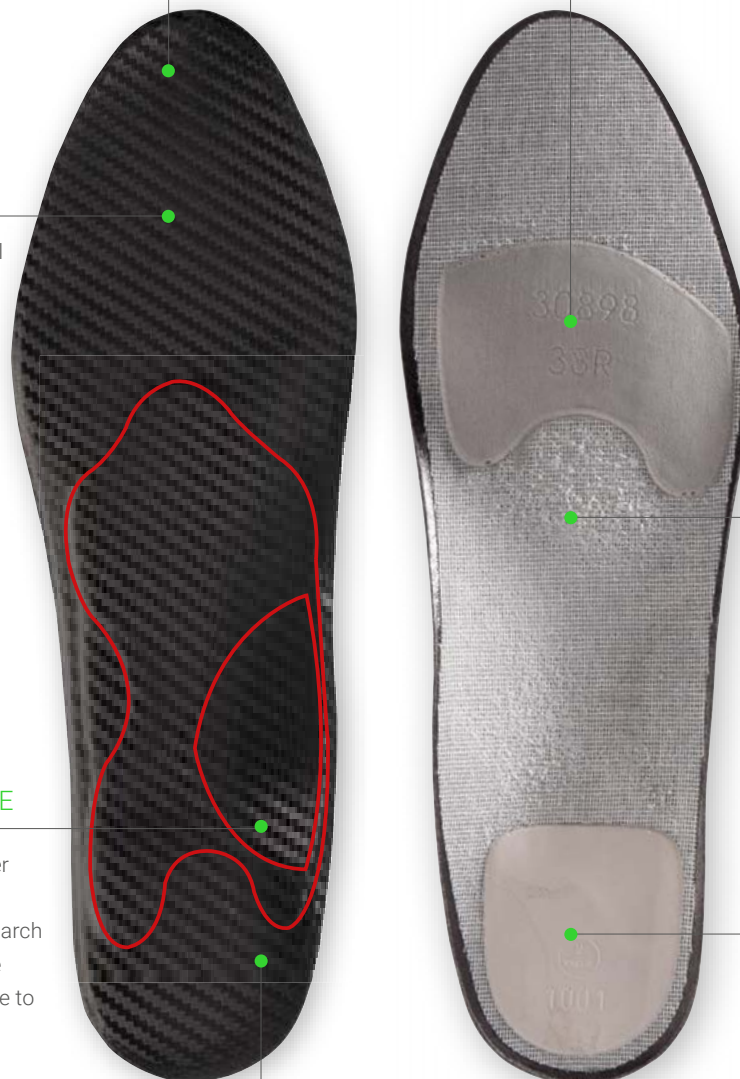

# DAILY<sup>2</sup> CONTROL

After further processing by orthopedic technicians the DAILY<sup>2</sup> CONTROL orthotic blank is ideally suited for feet with an increased lateral guiding requirement. The self-supporting but thin Perpedes glass fiber composite shell with its shell recess under the tuberosity 5th metatarsal and long wing section optimally supports the foot's longitudinal arch, guides the heel when walking. For optimized rear foot guidance, the DAILY CONTROL heel is cupped and,

for improved fit, it is lowered at the back. The glass fiber composite shell can be optionally shaped due to its thermoplastic properties and can, therefore, be uniquely adapted to the user's foot and requirements. An additional reinforcing textile layer gives the orthotic blank further stability in the forefoot area. Optionally, the DAILY<sup>2</sup> CONTROL can be supplemented by soft Carbosan foam met pads which support the transversal arch.



DAILY<sup>2</sup> CONTROL  
DACC\_

## CHARACTERISTICS

- Heel cupped blank, solid, (thermal) remoldable
- Long-soled soft cushion (optional)

## PRODUCT FACTS

Size range: 35 - 52  
 Width: Medium  
 Foot orthotic shell: Acrylic composite material made of knitted glass fiber (G431)  
 Outline: Business  
 Square  
 3D-Contour: DC = moderate longitudinal arch support, slight heel cup  
 Special feature: Cupped hindfoot  
 Long rear wings  
 Available with or without reinforcement under the tuberosity 5th metatarsal

## BESTSELLERS DAILY<sup>2</sup> CONTROL

ITEM NO. OLD	ITEM NO. NEW	BASE COVER	ADDITION	WIDTH	OUTLINE	LENGTH	SIZE RANGE
DCB_	DACB_	CarboTec titanium	-	Medium	Square	4/4	35 -52
DCC_	DACC_	CarboTec black	COMFORT soft zone padding	Medium	Business	4/4	35 -52

## BASE/BOTTOM COVER

CarboTec, titanium

### MATERIAL COMPOSITION

50% PUR + 50% PA

### CHARACTERISTICS

- High abrasion resistance
- Slightly slip-resistant
- Colorfast and lightfast

## FOOT ORTHOTIC SHELL

Acrylic composite material made of knitted (G431)

### CHARACTERISTICS

- Very good thermalplastic processing at approx. 140° C
- Optimal support of the foot's longitudinal arch

### FEATURE

Shell recess under the tuberosity 5th metatarsal and central heel

## LONG REAR WINGS

Stabilized heel by long rear wings.

## REINFORCING LAYER

Additional reinforcing layers provide smooth transitions and dimensional stability for the orthotic blank.

## CUPPED HEEL

For optimized rear foot guidance the heel is cupped and, for improved fit, it is lowered at the back. Due to the wide heel cup, top covers of our DryFeet+ are suitable.



# KID CONTROL

After further processing by orthopedic technicians the KID CONTROL orthotic blank is specially suited for children with Pes valgus and therefore increased need for rear foot guidance. Due to the KID CONTROL's small space requirements, the foot is not constricted in the child's shoe and it is, therefore, an ideal daily companion. The self-supporting Perpedes carbon fiber composite shell with its long rear wing section optimally supports the foot's longitudinal arch, guides the heel and still maintains the natural

feeling when walking. For optimized side stability, the rear foot area cupped and, for improved fit, it is lowered at the back. The carbon fiber composite shell can be optionally shaped due to its thermoplastic properties and can, therefore, be uniquely adapted to the child's foot and requirements. An additional reinforcing textile layer gives the orthotic blank further stability in the fore-foot area. Additionally, the KID CONTROL is equipped with a 3/4 COMFORT soft zone padding made from soft Carbosan foam.



KID CONTROL  
KIKT\_

## CHARACTERISTICS

- Heel cupped blank, solid, (thermal) remoldable
- Supination wedge (with base cover EVA), (optional)

## PRODUCT FACTS

Size range:	23 - 36
Width:	Medium
Foot orthotic shell:	Acrylic composite material made of knitted carbon fiber (C601)
Outline:	Vario
3D-Contour:	KC= moderate longitudinal arch support, high heel cup
Special feature:	Supination wedges available as spare parts Cupped hindfoot

## BESTSELLERS KID CONTROL

ITEM NO. <b>OLD</b>	ITEM NO. <b>NEW</b>	BASE COVER	ADDITION	WIDTH	LENGTH	SIZE RANGE
DKT_	KIKT_	CarboTec black	COMFORT soft zone padding	Medium	3/4	23 - 36
DK2_	KIK2_	CarboTec black	COMFORT soft zone padding	Medium	4/4	23 - 36
DK3_	KIK3_	EVA green	COMFORT soft zone padding + Supination wedge	Medium	4/4	23 - 36

## BASE/BOTTOM COVER

CarboTec, black

MATERIAL COMPOSITION  
50% PUR + 50% PA

### CHARACTERISTICS

- High abrasion resistance
- Slightly slip-resistant
- Colorfast and lightfast

## FOOT ORTHOTIC SHELL

Acrylic composite material made of knitted carbon fiber (G601)

### CHARACTERISTICS

- Very good thermal-plastic processing at 130° - 140° C
- Optimal support of the foot's longitudinal arch

## LONG REAR WINGS

Stabilized heel by long rear wings.

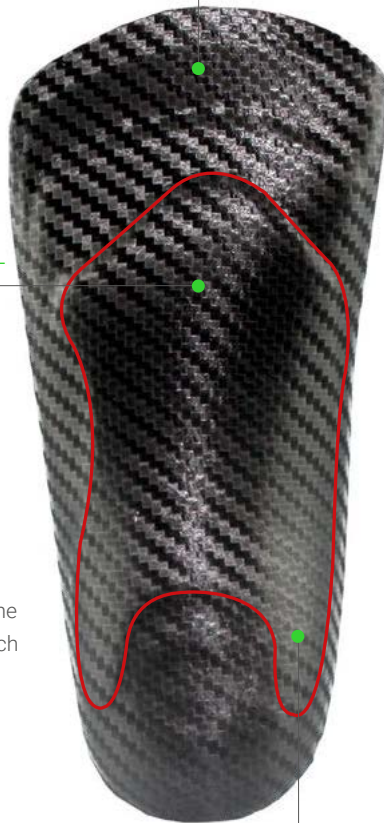

## COMFORT SOFT ZONE PADDING

Provides cushion, the pad's thin outline keeps the heel cup open for the foot.







## SOLEUTION

The SOLEUTION line is best suited to catering to complex clinical symptoms. SOLEUTION, SOLEUTION SUPPORT, SOLEUTION PRO, SOLEUTION PAPILLON, SOLEUTION CPX, SOLEUTION RIGIDUS and SOLEUTION CPH always offer the appropriate treatment option due to their indicative alignment. There is an unisex width available in two longitudinal arch supporting heights. The SOLEUTION line's centrepiece is the orthotic shell made from glass fiber composite materials we developed ourselves. Due to the thermoplastic properties, they are able to be adapted to the foot simply and quickly. In order to meet Perpedes' high quality demands, only selected and certificated materials which are perfectly matched with each other are used for the SOLEUTION line.

SOLEUTION PAPILLON  
Page 56

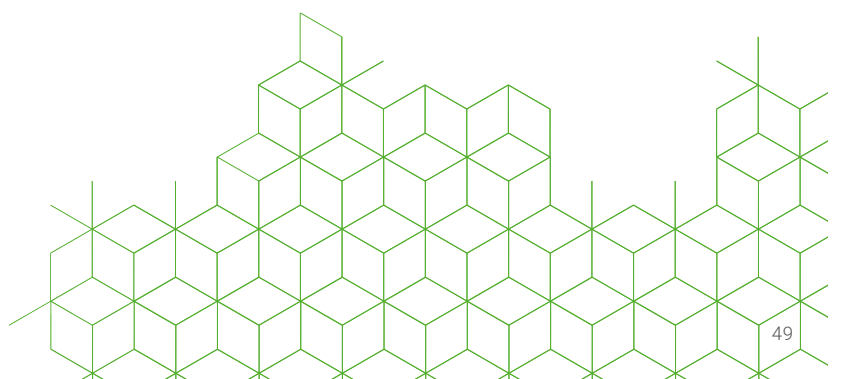

# SOLEUTION

The SOLEUTION orthotic blank forms the basis of the SOLEUTION line. The self-supporting Perpedes black glass fiber composite shell with its thin and flexible heel areas optimally supports the foot's longitudinal arch but still maintains the natural feeling when the foot touches the ground. The glass fiber composite shell, which is available in two longitudinal arch heights, can

be optionally shaped due to its thermoplastic properties and can, therefore, be uniquely adapted to the user's foot and requirements. Optionally, the SOLEUTION can be cut or ground narrower and be supplemented by soft Carbosan foam met pads which support the transversal arch.



SOLEUTION  
SOBE\_

## CHARACTERISTICS

- Supportive foot orthotic blank



Compatible with the  
**BALANCER - HEEL POST MODUL**

## PRODUCT FACTS

- Size range: 35 - 48
- Width: Medium
- Foot orthotic shell: Acrylic composite material made of knitted glass fiber and knitted polyamide (BF7002)
- Outline: Square, Natural outline
- 3D-Contour: SH = high longitudinal arch support with guided heel  
SM = low longitudinal arch support with guided heel
- Special feature: Heel area without shell

## BESTSELLERS SOLEUTION

ITEM NO. OLD	ITEM NO. NEW	BASE COVER	WIDTH	OUTLINE	3D-CONTOUR	LENGTH	SIZE RANGE
SBE_	SOBE_	CarboTec titanium	Medium	Square	SH	4/4	35 - 48
SBF_	SOBF_	Fleece Tex black	Medium	Square	SH	4/4	35 - 48



To the product video

### BASE/BOTTOM COVER

CarboTec, titanium

MATERIAL COMPOSITION  
50% PUR + 50% PA

- CHARACTERISTICS
- High abrasion resistance
  - Slightly slip-resistant
  - Colorfast and lightfast

Also available with  
base cover:  
Fleece Tex, black

### FOOT ORTHOTIC SHELL

Acrylic composite material made of knitted glass fiber and knitted polyamide (BF7002)

- CHARACTERISTICS
- Good thermalplastic processing at 130° - 140° C
  - Optimal support of the foot's longitudinal arch

### HEEL AREA WITHOUT SHELL

Thin heel portion for a natural feeling for ground contact.

### REINFORCING LAYER

An additional reinforcing layer provides smooth transitions and gives the orthotic blank further stability.

### HEEL AREA WITHOUT SHELL

Thin heel portion for a natural feeling for ground contact.



# SOLEUTION SUPPORT

After further processing by orthopedic technicians the SOLEUTION SUPPORT orthotic blank is ideally suited for foot complaints, found with fallen longitudinal foot arches. The self-supporting Perpedes glass fiber composite shell with its thin and flexible heel areas dynamically supports the arch by the added carbon fiber layer and therefore counteracts problems due to overloading. The

glass fiber composite shell, which is available in two longitudinal arch heights, can be optionally shaped due to its thermoplastic properties and can, therefore, be uniquely adapted to the user's foot and requirements. Additionally, the SOLEUTION SUPPORT can be cut or ground narrower and be supplemented by soft Carbosan foam met pads which support the transversal arch.



SOLEUTION SUPPORT  
SOSE\_

## CHARACTERISTICS

- Supportive foot orthotic blank
- Supination wedge



Compatible with the  
**BALANCER - HEEL POST MODUL**

## PRODUCT FACTS

Size range:	35 - 48
Width:	Medium
Foot orthotic shell:	Acrylic composite material made of woven glassfiber and knitted polyamide (GH702)
Outline:	Square, Natural outline
3D-Contour:	SH = high longitudinal arch support with guided heel SM = low longitudinal arch support with guided heel
Special feature:	Supination wedge made from composite carbon fiber material (C901) Heel area without shell

## BESTSELLERS SOLEUTION SUPPORT

ITEM NO. <b>OLD</b>	ITEM NO. <b>NEW</b>	BASE COVER	WIDTH	OUTLINE	3D-CONTOUR	LENGTH	SIZE RANGE
SSE_	SOSE_	CarboTec titanium	Medium	Square	SH	4/4	35 - 48
SSF_	SOSF_	Fleece Tex black	Medium	Square	SH	4/4	35 - 48

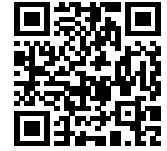

To the product video

### BASE/BOTTOM COVER

CarboTec, titanium

#### MATERIAL COMPOSITION

50% PUR + 50% PA

#### CHARACTERISTICS

- High abrasion resistance
- Slightly slip-resistant
- Colorfast and lightfast

Also available with

base cover:

Fleece Tex, black

### FOOT ORTHOTIC SHELL

Acrylic composite material made of woven glass fiber and knitted polyamide (GH702)

#### CHARACTERISTICS

- Good thermalplastic processing at 130° - 140° C
- Optimal support of the foot's longitudinal arch

### SUPINATION WEDGE

By using an additional layer made from carbon fiber material (C901), the foot's arch is supported and therefore counteracts problems due to overpronation.

### REINFORCING LAYER

An additional reinforcing layer provides smooth transitions and gives the orthotic blank further stability.

### HEEL AREA WITHOUT SHELL

Thin heel portion for a natural feeling for ground contact.



# SOLEUTION PRO

After further processing by orthopedic technicians the SOLEUTION PRO orthotic blank is ideally suited for people with supinating gait pattern. The self-supporting Perpedes glass fiber composite shell, which can be thermally remolded and is available in two longitudinal arch heights, with its thin and flexible heel areas dynamicaly supports the foot's longitudinal arch and has a thin heel area.

By using a midfoot/forefoot pronation wedge, the lateral portion of the foot is raised so that problems due to overloading, also in the knee joint, can be counteracted. Optionally, the SOLEUTION PRO can be cut or ground narrower and be supplemented by soft Carbosan foam met pads which support the transversal arch.



SOLEUTION PRO  
SOOE\_

## CHARACTERISTICS

- Supportive foot orthotic blank
- Pronations wedge



Compatible with the  
**BALANCER - HEEL POST MODUL**

## PRODUCT FACTS

- Size range: 35 - 48
- Width: Medium
- Foot orthotic shell: Acrylic composite material made of woven glass fiber and knitted polyamide (GH702)
- Outline: Square, Natural outline
- 3D-Contour: SH = high longitudinal arch support with guided heel  
SM = low longitudinal arch support with guided heel
- Special feature: Heel area without shell

## BESTSELLERS SOLEUTION PRO

ITEM NO. OLD	ITEM NO. NEW	BASE COVER	WIDTH	OUTLINE	3D-CONTOUR	LENGTH	SIZE RANGE
SOE_	SOOE_	CarboTec titanium	Medium	Square	SH	4/4	35 - 48
SOF_	SOOF*	Fleece Tex black	Medium	Square	SH	4/4	35 - 48



To the product video

### BASE/BOTTOM COVER

CarboTec, titanium

#### MATERIAL COMPOSITION

50% PUR + 50% PA

#### CHARACTERISTICS

- High abrasion resistance
- Slightly slip-resistant
- Colorfast and lightfast

Also available with base cover:

Fleece Tex, black

### PRONATION WEDGE

By using an additional layer made from carbon fiber composite (C901), the lateral portion of the midfoot/forefoot is raised so that problems due to overloading, also in the knee joint, can be counteracted.

### FOOT ORTHOTIC SHELL

Acrylic composite material made of woven glass fiber and knitted polyamide (GH702)

#### CHARACTERISTICS

- Good thermalplastic processing at 130° - 140° C
- Optimal support of the foot's longitudinal arch

### REINFORCING LAYER

An additional reinforcing layer provides smooth transitions and gives the orthotic blank further stability.

### HEEL AREA WITHOUT SHELL

Thin heel portion for a natural feeling for ground contact.

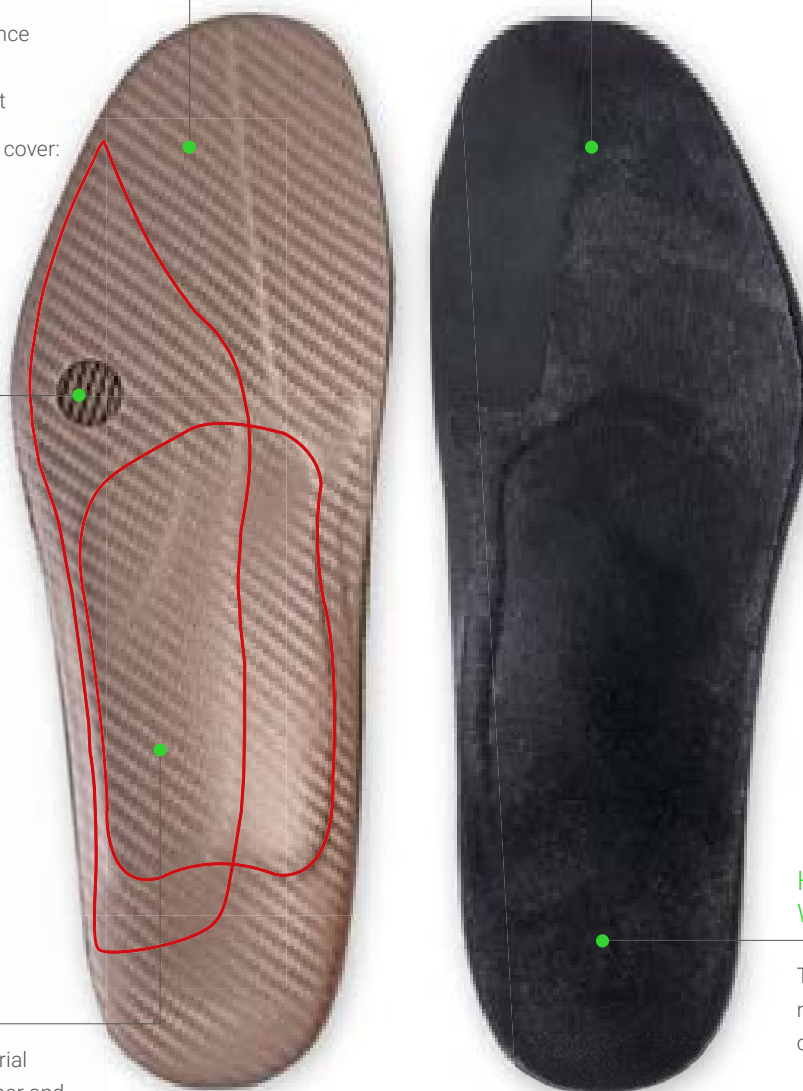

# SOLEUTION PAPILLON

After further processing by orthopedic technicians the SOLEUTION PAPILLON orthotic blank is ideally suited for advanced forefoot complaints. The slightly more stable bridge-like areas made of thermo cork in the medial and lateral forefoot relieve the central MTP joints. The high-quality Shock Absorber X (PUR foam) also minimizes the feeling of pressure. The self-supporting Perpedes glass fiber composite shell with its medial reinforcement and thin

and flexible heel also supports the foot's longitudinal arch. The orthotic shell, which is available in two longitudinal arch heights, can be optionally shaped due to its thermoplastic properties and can, therefore, be uniquely adapted to the user's foot and requirements. Optionally, the SOLEUTION PAPILLON can be cut or ground narrower and be supplemented by soft Carbosan foam met pads which support the transversal arch.



SOLEUTION PAPILLON  
SOAE\_

## CHARACTERISTICS

- Supportive foot orthotic blank
- Supination wedge
- Forefoot soft cushion



Compatible with the  
**BALANCER - HEEL POST MODUL**

## PRODUCT FACTS

- Size range: 35 - 48
- Width: Medium
- Foot orthotic shell: Acrylic composite material made of woven glass fiber and knitted polyamide (GH702)
- Outline: Square, Natural outline
- 3D-Contour: SH = high longitudinal arch support with guided heel  
SM = low longitudinal arch support with guided heel
- Special feature: Forefoot cushion pad made from Shock Absorber X PUR material  
Relief for MTP joints

## BESTSELLERS SOLEUTION PAPILLON

ITEM NO. OLD	ITEM NO. NEW	BASE COVER	WIDTH	OUTLINE	3D-CONTOUR	LENGTH	SIZE RANGE
SAE_	SOAE_	CarboTec titanium	Medium	Square	SH	4/4	35 - 48
SAF_	SOAF_	Fleece Tex black	Medium	Square	SH	4/4	35 - 48



To the product video

### BASE/BOTTOM COVER

CarboTec, titanium

#### MATERIAL COMPOSITION

50% PUR + 50% PA

#### CHARACTERISTICS

- High abrasion resistance
- Slightly slip-resistant
- Colorfast and lightfast

Also available with base cover:

Fleece Tex, black

### FOOT ORTHOTIC SHELL

Acrylic composite material made of woven glass fiber and knitted polyamide (GH702)

#### CHARACTERISTICS

- Good thermalplastic processing at 130° - 140° C
- Optimal support of the foot's longitudinal arch

### SUPINATION WEDGE

By using an additional layer made from carbon fiber material (C901), the foot's arch is supported and therefore counteracts problems due to overpronation.

### FOREFOOT CUSHION PAD

Forefoot cushion pad made of yellow 7° Shore A Shock Absorber X (PUR) to relief from pressure.

### METATARSAL RELIEF

The forefoot area is designed to maintain contact on the medial and lateral edges that alleviates the discomfort in the central MTP-joints.

### REINFORCING LAYER

An additional reinforcing layer provides smooth transitions and gives the orthotic blank further stability.

### HEEL AREA WITHOUT SHELL

Thin heel portion for a natural feeling for ground contact.



# SOLEUTION CPX

After further processing by orthopedic technicians the SOLEUTION CPX orthotic blank is ideally suited for painful clinical complaints due to overloading in the heel area, e.g. for plantar fasciitis or Calcaneal spur. The shell's heel recess in combination with the low positioning of the plantar fascia in the self-supporting Perpedes glass fiber composite shell is orientated on the fascia's anatomical location and runs well within the foot's longitudinal arch. The Shock Absorber X hindfoot pad in combination with

the incorporated PUR Slow-Memory foam optimally reduce impact forces, that affect the heel with every step. The glass fiber composite shell can be optionally shaped due to its thermoplastic properties and can, therefore, be uniquely adapted to the user's foot and requirements. Additionally, the SOLEUTION CPX can be cut or ground narrower and be supplemented by soft Carbosan foam met pads which support the transversal arch.



SOLEUTION CPX  
SOPP\_

## CHARACTERISTICS

- Supportive foot orthotic blank
- Calcaneal spur recess and cushion
- Long-soled soft cushion (optional)



Compatible with the  
**BALANCER - HEEL POST MODUL**

## PRODUCT FACTS

- Size range: 35 - 48
- Width: Medium
- Foot orthotic shell: Acrylic composite material made of woven glass fiber and knitted polyamide (GH702)
- Outline: Square, Natural outline
- 3D-Contour: PX = moderate longitudinal arch support with plantar fascia groove in the shell
- Special feature: Hindfoot cushion pad made from Shock Absorber X PUR material  
Anatomically correct recess for plantar fasciitis / heel spur

## BESTSELLERS SOLEUTION CPX

ITEM NO. OLD	ITEM NO. NEW	BASE COVER	WIDTH	OUTLINE	LENGTH	SIZE RANGE
SPA_	SOPP_	CarboTec black	Medium	Square	4/4	35 - 48



To the product video

### BASE/BOTTOM COVER

CarboTec, black

#### MATERIAL COMPOSITION

50% PUR + 50% PA

#### CHARACTERISTICS

- High abrasion resistance
- Slightly slip-resistant
- Colorfast and lightfast

### FOOT ORTHOTIC SHELL

Acrylic composite material made of woven glass fiber and knitted polyamide (GH702)

#### CHARACTERISTICS

- Good thermalplastic processing at 130° - 140° C
- Optimal support of the foot's longitudinal arch

### HEEL RECESS WITH FASCIA GROOVE

The shell's anatomically correct heel recess in combination with the low positioning of the fascia runs well within the foot's longitudinal arch.

### REINFORCING LAYER

An additional reinforcing layer provides smooth transitions and gives the orthotic blank further stability.

### FASCIA CUSHION

Fascia cushion made of red 12° Shore A PUR Slow Memory foam to relieve the plantar fascia from pressure.

### HINDFOOT CUSHION

Soft hindfoot cushion made of yellow 7° Shore A Shock Absorber X PUR material to absorb impact forces.

### HEEL SPUR CUSHION PAD

Heel spur cushion pad made of yellow 7° Shore A Shock Absorber X (PUR) has a dampening and pain-relieving effect.



# SOLEUTION RIGIDUS

After further processing by orthopedic technicians the SOLEUTION RIGIDUS orthotic blank is ideally suited to use for complaints in the big toe area, e.g. in the case of Hallux limitus. The self-supporting Perpedes glass fiber composite shell with its arch reinforcement and thin and flexible heel areas dynamically supports the foot's longitudinal arch and is extended on the big toe in such a way that the MTP joint 1 is spared from painful movement-related

deflections whilst walking. The orthotic shell, which is available in two longitudinal arch heights, can be optionally shaped due to its thermoplastic properties and can, therefore, be uniquely adapted to the user's foot and requirements. Additionally, the SOLEUTION RIGIDUS can be cut or ground narrower and be supplemented by soft Carbosan foam met pads which support the transversal arch.



SOLEUTION RIGIDUS  
SOHE\_

## CHARACTERISTICS

- Supportive foot orthotic blank
- Supination wedge
- Rigidus splint
- Forefoot soft cushion



Compatible with the  
**BALANCER - HEEL POST MODUL**

## PRODUCT FACTS

- Size range: 35 - 48  
 Width: Medium  
 Foot orthotic shell: Acrylic composite material made of woven glass fiber and knitted polyamide (GH702)  
 Outline: Square, Natural outline  
 3D-Contour: SH = high longitudinal arch support with guided heel  
 SM = low longitudinal arch support with guided heel  
 Special feature: forefoot cushion pad made from Shock Absorber X PUR material  
 Heel area without shell

## BESTSELLERS SOLEUTION RIGIDUS

ITEM NO. OLD	ITEM NO. NEW	BASE COVER	WIDTH	OUTLINE	3D-CONTOUR	LENGTH	SIZE RANGE
SHE_	SOHE_	CarboTec titanium	Medium	Square	SH	4/4	35 - 48
SHF_	SOHF_	Fleece Tex black	Medium	Square	SH	4/4	35 - 48

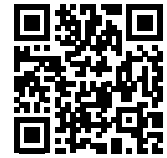

To the product video

## BASE/BOTTOM COVER

CarboTec, titanium

### MATERIAL COMPOSITION

50% PUR + 50% PA

### CHARACTERISTICS

- High abrasion resistance
- Slightly slip-resistant
- Colorfast and lightfast

Also available with base cover: Fleece Tex, black

## RIGIDUS SPLINT

Rigidus splint for motion-limiting reinforcement underneath the MTP-joint I

## FOOT ORTHOTIC SHELL

Acrylic composite material made of woven glass fiber and knitted polyamide (GH702)

### CHARACTERISTICS

- Good thermalplastic processing at 130° - 140° C
- Optimal support of the foot's longitudinal arch

## SUPINATION WEDGE

By using an additional layer made from carbon fiber material (C901), the foot's arch is supported and therefore counteracts problems due to overpronation.

## FOREFOOT CUSHION PAD

Forefoot cushion pad made of yellow 7° Shore A Shock Absorber X (PUR) to relief from pressure.

## REINFORCING LAYER

An additional reinforcing layer provides smooth transitions and gives the orthotic blank further stability.

## HEEL AREA WITHOUT SHELL

Thin heel portion for a natural feeling for ground contact.

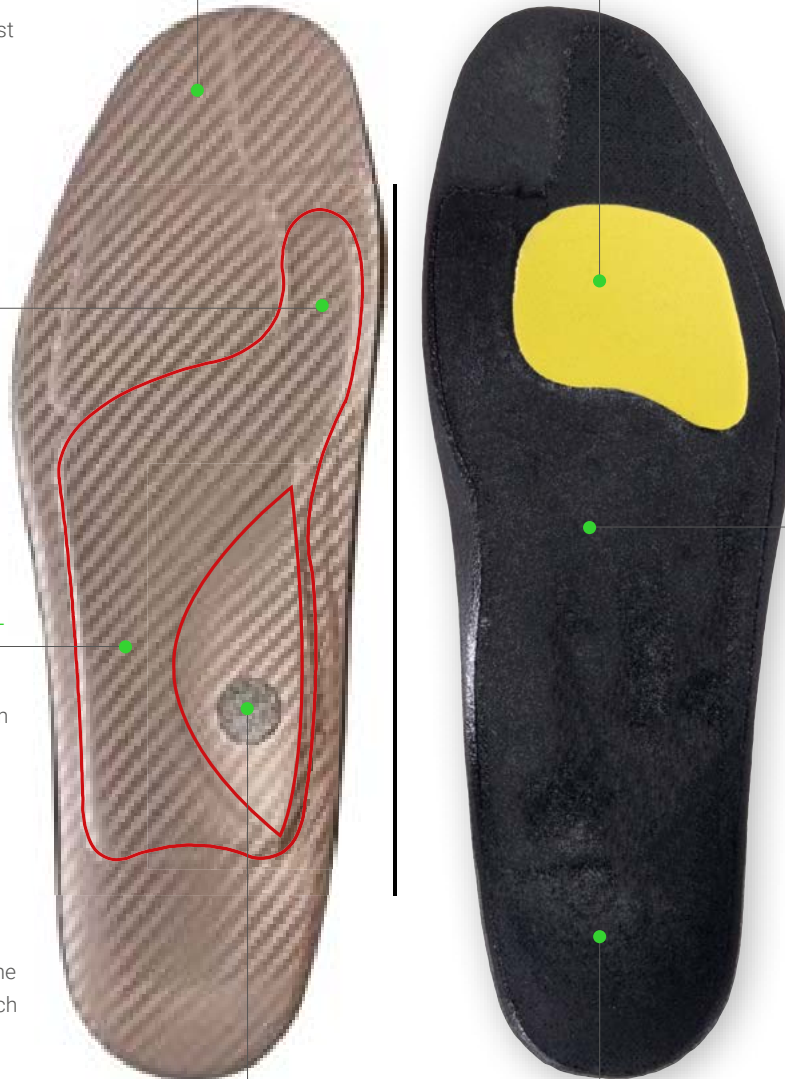

# SOLEUTION CPH

After further processing by orthopedic technicians the SOLEUTION CPH is ideally suited to use for particularly painful, movement-induced complaints due to overloading in the heel area. The shell's heel recess in combination with the low positioning of the plantar fascia in the self-supporting glass fiber shell is orientated on the fascia's anatomical location and runs well within the foot's longitudinal arch. The Shock Absorber X hindfoot pad in combination with the incorporated PUR Slow-Memory foam optimally

reduce impact forces, that affect the heel with every step. Further, the glass fiber shell extends underneath MTP I and reduces the typical movement-related deflections as well as fascial tension and, therefore, additional irritation when walking. Additionally, the SOLEUTION CPH can be cut or ground narrower and be supplemented by soft Carbosan foam met pads which support the transversal arch.



SOLEUTION CPH  
SOCA\_

## CHARACTERISTICS

- Supportive foot orthotic blank
- Calcaneal spur recess and cushion
- Rigidus splint
- Forefoot soft cushion



Compatible with the  
**BALANCER - HEEL POST MODUL**

## PRODUCT FACTS

- Size range: 35 - 48  
 Width: Medium  
 Foot orthotic shell: Acrylic composite material made of woven glass fiber and knitted polyamide (GH702)  
 Outline: Square, Natural outline  
 3D-Contour: PX = moderate longitudinal arch support with plantar fascia groove in the shell  
 Special feature: Forefoot and heel cushion pads made from Shock Absorber X PUR material  
 Anatomically correct recess for plantar fasciitis / heel spur with plantar fascia groove for maximum relief, combined with a rigidus splint

## BESTSELLERS SOLEUTION CPH

ITEM NO. OLD	ITEM NO. NEW	BASE COVER	WIDTH	OUTLINE	LENGTH	SIZE RANGE
SCA_	SOCA_	CarboTec black	Medium	Square	4/4	35 - 48



To the product video

## BASE/BOTTOM COVER

CarboTec, titanium

### MATERIAL COMPOSITION

50% PUR + 50% PA

### CHARACTERISTICS

- High abrasion resistance
- Slightly slip-resistant
- Colorfast and lightfast

## RIGIDUS SPLINT

Rigidus splint for motion-limiting reinforcement underneath the MTP-joint I

## FOOT ORTHOTIC SHELL

Acrylic composite material made of woven glass fiber and knitted polyamide (GH702)

### CHARACTERISTICS

- Good thermalplastic processing at 130° - 140° C
- Optimal support of the foot's longitudinal arch

## HEEL RECESS WITH FASCIA GROOVE

The shell's anatomically correct heel recess in combination with the low positioning of the fascia runs well within the foot's longitudinal arch.

## REINFORCING LAYER

An additional reinforcing layer provides smooth transitions and gives the orthotic blank further stability.

## FOREFOOT CUSHION PAD

Forefoot cushion pad made of yellow 7° Shore A Shock Absorber X (PUR) to relief from pressure.

## FASCIA CUSHION

Fascia cushion made of red 12° Shore A PUR Slow Memory foam to relief the plantar fascia from pressure.

## HINDFOOT CUSHION

Soft hindfoot cushion made of yellow 7° Shore A Shock Absorber X PUR material to absorb impact forces.

## HEEL SPUR CUSHION PAD

Heel spur cushion pad made of yellow 7° Shore A Shock Absorber X (PUR) has a dampening and pain-relieving effect.







## CALCA

The CALCA line combines effective pressure relief in the heel area with longitudinal arch support.

Best suited to treat frequently occurring, painful heel complaints, the CALCA II, the CALCA PRO X and the CALCA PRO XLE offer optimal care for pain-free walking.

The CALCA line's centrepiece is the orthotic shell made from glass fiber composite materials we developed and produce by ourselves. Due to its thermoplastic properties, the shells can be adapted to the user simply and uniquely. The heel relief provided in the orthotic shell is orientated on the plantar fascia's anatomical location and runs to the foot's longitudinal arch. This relieves the plantar structures and promotes positive therapy progression. High-quality materials which meet Perpedes' quality demands are used in the CALCA line. The foot orthotic's components are perfectly attuned with each other.

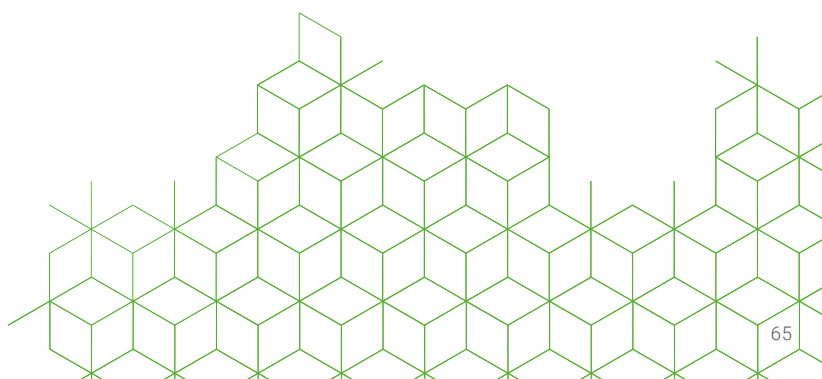

# CALCA II

After further processing by orthopedic technicians the CALCA II orthotic blank is ideally suited for chronically painful heel area complaints, e.g. plantar fasciitis or heel spurs. The particularly extensive, drop-shaped recess in the self-supporting Perpedes glass fiber composite shell is orientated on the plantar fascia's anatomical location and stretches to the foot's longitudinal arch. The moderate longitudinal arch support and the double layered PUR

Slow-Memory foam in the heel area have a dampening and pain relieving effect. The glass fiber composite shell, which is available in two widths, can be optionally shaped due to its thermo-plastic properties and can, therefore, be uniquely adapted to the user's foot and requirements. Additionally, the CALCA II can be supplemented by soft CarboTec foam met pads which support the transversal arch.



## CHARACTERISTICS

- Supportive foot orthotic blank
- Calcaneal spur recess and cushion



Compatible with the  
**BALANCER - HEEL POST MODUL**

## PRODUCT FACTS

- Size range: 35 - 48
- Width: Narrow (35 - 42) / Medium (35 - 48)
- Foot orthotic shell: Acrylic composite material made of woven glass fiber and knitted polyamide (GH702)
- Outline: Vario
- 3D-Contour: R = higher longitudinal arch support with guided heel
- Special feature: Hindfoot cushion pad made from different materials selectable  
Anatomically correct recess for Plantar fasciitis / heel spur

## BESTSELLERS CALCA II

ITEM NO. OLD	ITEM NO. NEW	BASE COVER	ADDITION	HINDFOOT CUSHION PAD	WIDTH	LENGTH	SIZE RANGE
C2L_	CA2L_	CarboTec black	-	3mm PUR-Slow-Memory 12° Shore A, red	Narrow	3/4	35 - 42
C2A_	CA2A_	CarboTec black	-	3mm PUR-Slow-Memory 12° Shore A, red	Medium	3/4	35 - 48
C2E_	CA2E_	CarboTec black	-	3mm PUR-Slow-Memory 12° Shore A, red	Medium	4/4	35 - 48



To the product video

## BASE/BOTTOM COVER

CarboTec, black

### MATERIAL COMPOSITION

50% PUR + 50% PA

### CHARACTERISTICS

- High abrasion resistance
- Slightly slip-resistant
- Colorfast and lightfast

Also available with base cover: Fleece Tex, black

## FOOT ORTHOTIC SHELL

Acrylic composite material made of woven glass fiber and knitted polyamide (GH702)

### CHARACTERISTICS

- Good thermalplastic processing at 130° - 140° C
- Optimal support of the foot's longitudinal arch

## HEEL RECESS

The particularly extensive, drop-shaped heel recess provides the space for a shock absorbing heel pad Calcaneus to the lateral, usually pain-free areas of the heel.

## REINFORCING LAYER

An additional reinforcing layer provides smooth transitions and gives the orthotic blank further stability.

## HINDFOOT CUSHION

The open celled, 3mm red PUR Slow Memory foam (Poron) in the heel area with its 12° Shore A is double layered in the shell's recess. This softness has a dampening and pain relieving effect, as it absorbs impact forces.

## HEEL SPUR CUSHION PAD

Heel spur cushion pad made of 3mm red PUR Slow Memory foam has a dampening and pain-relieving effect.



# CALCA BUSINESS

After further processing by orthopedic technicians the CALCA BUSINESS foot orthotic blank is ideally suited for chronically painful heel area complaints, e.g. plantar fasciitis or heel spurs. The particularly extensive, drop-shaped recess in the self-supporting Perpedes glass fiber composite shell is orientated on the plantar fascia's anatomical location and stretches to the foot's longitudinal arch. The PUR Slow-Memory foam in the heel area and the thin

COMFORT soft zone padding have a dampening and pain relieving effect. The glass fiber composite shell BF7003, which is available in two widths, can be optionally shaped due to its thermoplastic properties and can, therefore, be uniquely adapted to the user's foot and requirements. Additionally, the CALCA BUSINESS can be supplemented by soft CarboSan foam met pads which support the transversal arch.



CALCA BUSINESS  
CA2K

## CHARACTERISTICS

- Supportive foot orthotic blank
- Calcaneal spur recess and cushion
- COMFORT soft zone padding

## PRODUCT FACTS

Size range:	35 - 48
Width:	Narrow (35 - 43) / Medium (35 - 48)
Foot orthotic shell:	Solid acrylic composite material of knitted glass fiber and knitted polyamide (BF7003)
Outline:	Business
3D-Contur:	DA = moderate longitudinal arch support with slightly guided heel
Special feature:	Anatomically correct recess for Plantar fasciitis / heel spur COMFORT soft zone padding Solid, foot orthotic blank

## BESTSELLERS CALCA BUSINESS

ITEM NO. OLD	ITEM NO. NEW	WIDTH SHELL	BASE COVER	MATERIAL SHELL	BASE COVER	HINDFOOT CUSHION PAD	ADDITION	LENGTH	SIZE RANGE
C2K_	CA2K_	Narrow	Medium	BF7003	CarboTec titanium	3mm PUR-Slow-Memory 12° Shore A, red	COMFORT soft zone padding	4/4	35 - 43
C2N_	CA2N_	Narrow	Medium	BF7003	FleeceTex black	3mm PUR-Slow-Memory 12° Shore A, red	COMFORT soft zone padding	4/4	35 - 43
C2L_	CA2L_	Medium	Medium	BF7003	CarboTec titanium	3mm PUR-Slow-Memory 12° Shore A, red	COMFORT soft zone padding	4/4	35 - 48
C2O_	CA2O_	Medium	Medium	BF7003	FleeceTex black	3mm PUR-Slow-Memory 12° Shore A, red	COMFORT soft zone padding	4/4	35 - 48

## BASE/BOTTOM COVER

### ADVANTAGE

The narrow shell in combination with the medium base cover allows to fit this foot orthoses into business shoes

CarboTec, titanium

### MATERIAL COMPOSITION

50% PUR + 50% PA

### CHARACTERISTICS

- High abrasion resistance
- Slightly slip-resistant
- Colorfast and lightfast

Also available with

base cover:

FleeceTex, black

## FOOT ORTHOTIC SHELL

Solid acrylic composite material made of knitted glass fiber and knitted polyamide (BF7003)

### CHARACTERISTICS

- Good thermalplastic processing at 140° C
- Optimal support of the foot's longitudinal arch

## HEEL RECESS

The particularly extensive, drop-shaped heel recess provides the space for a shock absorbing heel pad and distributes the body load from the central Calcaneus to the lateral, usually pain-free areas of the heel.

## REINFORCING LAYER

An additional reinforcing layer provides smooth transitions and gives the orthotic blank further stability.

## COMFORT SOFT ZONE PADDING

Soft pressure zone padding made of Carbosan foam suitable for the limited volume of business footwear.

## HINDFOOT CUSHION

The open celled, 3mm red PUR-Slow-Memory foam (Poron) in the heel area with its 12° Shore A is double layered in the shell's recess. This softness has a dampening and pain relieving effect, as it absorbs impact forces.

## HEEL SPUR CUSHION PAD

Heel spur cushion pad made of 3mm red PUR-Slow-Memory foam has a dampening and pain-relieving effect.



# CALCA BUSINESS DYNAMIC

After further processing by orthopedic technicians the CALCA BUSINESS DYNAMIC foot orthotic blank is ideally suited for chronically painful heel area complaints, e.g. plantar fasciitis or heel spurs. The particularly extensive, drop-shaped recess in the self-supporting Perpedes glass fiber composite shell is orientated on the plantar fascia's anatomical location and stretches to the foot's longitudinal arch. The PUR Slow-Memory foam in the heel

area and the thin COMFORT soft zone padding have a dampening and pain relieving effect. The dynamic glass fiber composite shell BF7002, which is available in two widths, can be optionally shaped due to its thermoplastic properties and can, therefore, be uniquely adapted to the user's foot and requirements. Additionally, the CALCA BUSINESS DYNAMIC can be supplemented by soft Carbosan foam met pads which support the transversal arch.



CALCA BUSINESS DYNAMIC  
CA2JL

## CHARACTERISTICS

- Supportive foot orthotic blank
- Calcaneal spur recess and cushion
- COMFORT soft zone padding

## PRODUCT FACTS

- Size range: 35 - 48
- Width: Narrow (35 - 43) / Medium (35 - 48)
- Foot orthotic shell: Dynamic acrylic composite material made of knitted glass fiber and knitted polyamide (BF7002)
- Outline: Business
- 3D-Contur: DA = moderate longitudinal arch support with slightly guided heel
- Special feature: Anatomically correct recess for Plantar fasciitis / heel spur  
COMFORT soft zone padding  
Dynamic, foot orthotic blank

## BESTSELLERS CALCA BUSINESS

ITEM NO. OLD	ITEM NO. NEW	WIDTH SHELL	BASE COVER	MATERIAL SHELL	BASE COVER	HINDFOOT CUSHION PAD	ADDITION	LENGTH	SIZE RANGE
C2J_	CA2J_	Narrow	Medium	BF7002	FleeceTex black	3mm PUR-Slow-Memory 12° Shore A, red	COMFORT soft zone padding	4/4	35 - 43
C2P_	CA2P_	Narrow	Medium	BF7002	CarboTec titanium	3mm PUR-Slow-Memory 12° Shore A, red	COMFORT soft zone padding	4/4	35 - 43
C2M_	CA2M_	Medium	Medium	BF7002	FleeceTex black	3mm PUR-Slow-Memory 12° Shore A, red	COMFORT soft zone padding	4/4	35 - 48
C2Q_	CA2Q_	Medium	Medium	BF7002	CarboTec titanium	3mm PUR-Slow-Memory 12° Shore A, red	COMFORT soft zone padding	4/4	35 - 48

## BASE/BOTTOM COVER

### ADVANTAGE

The narrow shell in combination with the medium base cover allows to fit this foot orthoses into business shoes

FleeceTex, black

### MATERIAL COMPOSITION

Synthetic fleece

### CHARACTERISTICS

- High abrasion resistance
- Water vapour permeable
- Good moisture absorption and release
- Breathable
- Colorfast and lightfast

Also available with base cover: CarboTec, titanium

## FOOT ORTHOTIC SHELL

Dynamic acrylic composite material made of knitted glass fiber and knitted polyamide (BF7002)

### CHARACTERISTICS

- Good thermalplastic processing at 140° C
- Optimal support of the foot's longitudinal arch

## HEEL RECESS

The particularly extensive, drop-shaped heel recess provides the space for a shock absorbing heel pad and distributes the body load from the central Calcaneus to the lateral, usually pain-free areas of the heel.

## REINFORCING LAYER

An additional reinforcing layer provides smooth transitions and gives the orthotic blank further stability.

## COMFORT SOFT ZONE PADDING

Soft pressure zone padding made of Carbosan foam suitable for the limited volume of business footwear.

## HINDFOOT CUSHION

The open celled, 3mm red PUR-Slow-Memory foam (Poron) in the heel area with its 12° Shore A is double layered in the shell's recess. This softness has a dampening and pain relieving effect, as it absorbs impact forces.

## HEEL SPUR CUSHION PAD

Heel spur cushion pad made of 3mm red PUR-Slow-Memory foam has a dampening and pain-relieving effect.



# CALCA PRO X

After further processing by orthopedic technicians the CALCA PRO X orthotic blank is the original and designed particularly for acutely painful complaints due to overloading in the heel area. The shell's heel recess in combination with the unique low positioned groove for the plantar fascia in the self-supporting Perpedes glass fiber composite shell is orientated on the fascia's anatomical location and runs well within the foot's longitudinal arch. The moderate arch support and the double layered yellow 3 mm Shock

Absorber X hindfoot pad in combination with the incorporated red PUR Slow-Memory foam optimally reduce impact forces, that affect the heel with every step. The orthotic shell can be optionally shaped due to its thermoplastic properties and can, therefore, be uniquely adapted to the user's foot and requirements. Additionally, the CALCA PRO X can be supplemented by soft Carbosan foam met pads which support the transversal arch.



## CHARACTERISTICS

- Supportive foot orthotic blank
- Calcaneal spur recess and cushion



Compatible with the  
**BALANCER - HEEL POST MODUL**

## PRODUCT FACTS

Size range: 35 - 48  
 Width: Narrow (35 - 44) / Medium (35 - 48)  
 Foot orthotic shell: Acrylic composite material made of woven glass fiber and knitted polyamide (GH702)  
 Outline: Square  
 3D-Contour: PX = moderate longitudinal arch support with plantar fascia groove in the shell  
 Special feature: Hindfoot cushion pad made from different materials selectable  
 Anatomically correct recess for plantar fasciitis / heel spur with plantar fascia groove for maximum relief

## BESTSELLERS CALCA PRO X

ITEM NO. OLD	ITEM NO. NEW	BASE COVER	HINDFOOT CUSHION PAD	WIDTH	LENGTH	SIZE RANGE
CPA_	CAPA_	CarboTec black	3mm Shock Absorber X 7° Shore A, yellow	Medium	3/4	35 - 48
CPS_	CAPS_	CarboTec black	3mm Shock Absorber X 7° Shore A, yellow	Narrow	4/4	35 - 44
CPE_	CAPE_	CarboTec black	3mm Shock Absorber X 7° Shore A, yellow	Medium	4/4	35 - 48
CUA_	CAUA_ BLUE EDITION	CarboTec black	3mm PUR-Memory 15° Shore A, blue	Medium	4/4	35 - 48

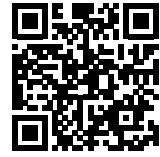

To the product video

### BASE/BOTTOM COVER

CarboTec, black

MATERIAL COMPOSITION  
50% PUR + 50% PA

- CHARACTERISTICS
- High abrasion resistance
  - Slightly slip-resistant
  - Colorfast and lightfast

Also available with base cover:  
TPU, black

### REINFORCING LAYER

An additional reinforcing layer provides smooth transitions and gives the orthotic blank further stability.

### FOOT ORTHOTIC SHELL

Acrylic composite material made of woven glass fiber and knitted polyamide (GH702)

- CHARACTERISTICS
- Good thermalplastic processing at 130° - 140° C
  - Optimal support of the foot's longitudinal arch

### FASCIA CUSHION

An incorporated cushion pad made of 3mm red 12° Shore A PUR Slow Memory foam relieves the plantar fascia from pressure.

### HINDFOOT CUSHION

The open celled, 3mm yellow Shock Absorber X PUR foam in the heel area with its 7° Shore A is double layered in the shell's recess. This softness has an dampening and pain relieving effect, as it effectively absorbs impact forces.

### HEEL RECESS WITH FASCIA GROOVE

The shell's anatomically correct heel recess in combination with the low positioning of the fascia runs well within the foot's longitudinal arch. The heel recess provides the space for a shock absorbing heel pad and distributes the body load from the central Calcaneus to the lateral, usually pain-free areas of the heel.

### HEEL SPUR CUSHION PAD

Heel spur cushion pad made of yellow 7° Shore A Shock Absorber X (PUR) has a dampening and pain-relieving effect.



# CALCA PRO X XL

After further processing by orthopedic technicians the CALCA PRO X XL foot orthotic blank is especially suitable for heavier patients with large, wider feet and painful complaints in the heel area, e.g. plantar fasciitis or Calcaneal spur. The anatomically shaped heel recess in combination with the shell's groove for the plantar fascia corresponds to the Calca Pro X, which has been successfully available on the market for years; for the XL version a 6 mm wider, thicker and therefore more stable Perpedes glass fiber shell is used. The long-lasting PUR Medical pad together with

the integrated PUR Medical foam softly embeds the plantar fascia and thus distributes the body load optimally under the rear foot. This ensures timely pain relief and prevents chronic symptoms. The orthotic shell can be optionally shaped as usual due to its thermoplastic properties and can, therefore, be uniquely adapted to the user's foot and requirements. Additionally, the CALCA PRO X can be supplemented by soft Carbosan foam met pads which support the transversal arch.



CALCA PRO X XL  
CAXL\_

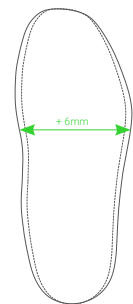

The 6mm wider outline in combination with the reinforced glass fiber composite shell (G422) offer sufficient support for wider feet.

## CHARACTERISTICS

Supportive foot orthotic blank  
Calcaneal spur recess and cushion



Compatible with the  
**BALANCER - HEEL POST MODUL**

## PRODUCT FACTS

Size range: 35 - 52  
Width: Wide  
Foot orthotic shell: Acrylic composite material made of knitted glass fiber (G422)  
Outline: Square  
3D-Contour: PX = moderate longitudinal arch support with plantar fascia groove in the shell  
Special feature: Anatomically correct recess for plantar fasciitis / heel spur with plantar fascia groove for maximum relief  
Broadened and reinforced foot orthotic shell

## BESTSELLERS CALCA PRO X XL

ITEM NO. OLD	ITEM NO. NEW	BASE COVER	HINDFOOT CUSHION PAD	WIDTH	LENGTH	SIZE RANGE
CXL_	CAXL_	CarboTec black	3mm PUR Medical 12 ° Shore A, beige	Wide	4/4	35 - 52

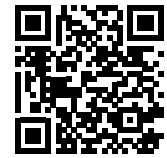

To the product video

## BASE/BOTTOM COVER

CarboTec, black

MATERIAL COMPOSITION  
50% PUR + 50% PA

- CHARACTERISTICS
- High abrasion resistance
  - Slightly slip-resistant
  - Colorfast and lightfast

## FOOT ORTHOTIC SHELL

Acrylic composite material made of knitted glass fiber (G422)

- CHARACTERISTICS
- Good thermalplastic processing at 130° - 140° C
  - Optimal support of the foot's longitudinal arch

## HEEL RECESS WITH FASCIA GROOVE

The shell's anatomically correct heel recess in combination with the low positioning of the fascia runs well within the foot's longitudinal arch. The heel recess provides the space for a shock absorbing heel pad and distributes the body load from the central Calcaneus to the lateral, usually pain-free areas of the heel.

## REINFORCING LAYER

An additional reinforcing layer provides smooth transitions and gives the orthotic blank further stability.

## FASCIA CUSHION

An incorporated fascia cushion pad made of 3mm red 12° Shore A PUR Slow Memory foam relieves the plantar fascia from pressure.

## HINDFOOT CUSHION

The open celled, 3mm beige PUR Medical foam in the heel area with its 12° Shore A for all conditions that require an extra thick padding and impact relieving effect.

## HEEL SPUR CUSHION PAD

Incorporated heel cushion pad made of 3mm beige PUR Medical material to optimally reduce impact forces.

# CALCA PRO XLE

The CALCA PRO XLE orthotic blank is based on the CALCA PRO X and prioritizes the low positioned groove for the plantar fascia in its progression through the foot's longitudinal arch in an otherwise identical structure and function. After further processing by orthopedic technicians the CALCA PRO XLE is therefore ideally suited to take care of acutely painful complaints due to overloading in the heel area. The moderate longitudinal arch support and the double

layered yellow 3 mm Shock Absorber X PUR cushioning material reduce impact forces, that affect the heel with every step. The glass fiber composite shell can be optionally shaped due to its thermoplastic properties and can, therefore, be uniquely adapted to the user's foot and requirements. Additionally, the CALCA PRO XLE can be supplemented by soft Carbosan foam met pads which support the transversal arch.



## CHARACTERISTICS

- Supportive foot orthotic blank
- Calcaneal spur recess and cushion



Compatible with the  
**BALANCER - HEEL POST MODUL**

## PRODUCT FACTS

- Size range: 35 - 48  
 Width: Medium  
 Foot orthotic shell: Acrylic composite material made of woven glass fiber and knitted polyamide (GH702)  
 Outline: Square  
 3D-Contour: PX = moderate longitudinal arch support with plantar fascia groove in the shell  
 Special feature: Hindfoot cushion pad made from different materials selectable  
 Anatomically correct recess for plantar fasciitis / heel spur with fascial groove for maximum relief

## BESTSELLERS CALCA PRO XLE

ITEM NO. OLD	ITEM NO. NEW	BASE COVER	HINDFOOT CUSHION PAD	WIDTH	LENGTH	SIZE RANGE
CPC_	CAPC_	CarboTec black	3mm Shock Absorber X, 7° Shore A, yellow	Medium	3/4	35 - 48
CPD_	CAPD_ BLUE EDITION	CarboTec black	3mm PUR-Memory 15° Shore A, blue	Medium	4/4	35 - 48



To the product video

## BASE/BOTTOM COVER

CarboTec, black

### MATERIAL COMPOSITION

50% PUR + 50% PA

### CHARACTERISTICS

- High abrasion resistance
- Slightly slip-resistant
- Colorfast and lightfast

Also available with base cover: TPU, black

## REINFORCING LAYER

An additional reinforcing layer provides smooth transitions and gives the orthotic blank further stability.

## FOOT ORTHOTIC SHELL

Acrylic composite material made of woven glass fiber and knitted polyamide (GH702)

### CHARACTERISTICS

- Good thermalplastic processing at 130° - 140° C
- Optimal support of the foot's longitudinal arch

## HEEL RECESS WITH FASCIA GROOVE

The shell's anatomically correct heel recess in combination with the low positioning of the fascia runs well within the foot's longitudinal arch. The heel recess provides the space for a shock absorbing heel pad and distributes the body load from the central Calcaneus to the lateral, usually pain-free areas of the heel.

## LOW POSITIONED PLANTAR FASCIA

Low positioned groove WITHOUT incorporated cushion pad to relieve the plantar fascia from pressure.

## HINDFOOT CUSHION

The open celled, 3mm yellow Shock Absorber X PUR foam in the heel area with its 7° Shore A is double layered in the shell's recess. This softness has a dampening and pain relieving effect, as it effectively absorbs impact forces.

## HEEL SPUR CUSHION PAD

Heel spur cushion pad made of yellow 7° Shore A Shock Absorber X (PUR) has a dampening and pain-relieving effect.



# CALCA PRO X CONTROL

After further processing by orthopedic technicians the CALCA PRO X CONTROL is ideally suited to provide patients with painful complaints (due to overloading in the heel area) with an increased lateral guiding by a cupped heel. The shell's heel recess in combination with the unique low positioned groove for the plantar fascia in the self-supporting PERPEDES glass fiber composite shell is orientated on the fascia's anatomical location and runs well within the foot's longitudinal arch. The moderate arch support and the 2.8 mm Slow-Memory hindfoot pad made of SBR (synthetic latex)

combined with the incorporated Shock Absorber X PUR foam optimally reduces impact forces, that positively affect the heel with every step. The orthotic shell can be optionally modified due to its thermoplastic properties and can, therefore, be uniquely adapted to the user's foot and requirements. Additionally, the CALCA PRO X CONTROL can be supplemented by soft Carbosan foam met pads, which support the transversal arch, as well as with our Balancer heel posts.



CALCA PRO X CONTROL  
CAPO\_

## CHARACTERISTICS

- Supportive foot orthotic blank with cupped heel
- Calcaneal spur recess and cushion



Compatible with the  
**BALANCER - HEEL POST MODUL**

## PRODUCT FACTS

- Size range: 35 - 48  
 Width: Medium  
 Foot orthotic shell: Acrylic composite material made of woven glass fiber and knitted polyamide (GH702)  
 Outline: Square  
 3D-Contour: PXC = moderate longitudinal arch support with plantar fascia groove in the shell and guided heel  
 Special feature: Cupped hindfoot  
 Anatomically correct recess to encounter Plantar fasciitis / heel spur

## BESTSELLER CALCA PRO X CONTROL

ITEM NO. OLD	ITEM NO. NEW	BASE COVER	HINDFOOT CUSHION PAD	WIDTH	LENGTH	SIZE RANGE
CPO_	CAPO_	CarboTec black	2.8mm SBR Memory 12° Shore A, red	Medium	4/4	35 - 48

## BASE/BOTTOM COVER

CarboTec, black

### MATERIAL COMPOSITION

50% PUR + 50% PA

### CHARACTERISTICS

- High abrasion resistance
- Slightly slip-resistant
- Colorfast and lightfast

## FOOT ORTHOTIC SHELL

Acrylic composite material made of woven glass fiber and knitted polyamide (GH702)

### CHARACTERISTICS

- Good thermalplastic processing at 130° - 140° C
- Optimal support of the foot's longitudinal arch

### FEATURE

Shell recess under the tuberosity 5th metatarsal and heel

## HEEL RECESS WITH FASCIA GROOVE

The shell's anatomically correct heel recess in combination with the low positioning of the fascia runs well within the foot's longitudinal arch. The heel recess provides the space for a shock absorbing heel pad and distributes the body load from the central Calcaneus to the lateral, usually pain-free areas of the heel.

## REINFORCING LAYER

An additional reinforcing layer provides smooth transitions and gives the orthotic blank further stability.

## FASCIA CUSHION

An incorporated cushion pad made of 1.5mm red 12° Shore A PUR Slow Memory foam relieves the plantar fascia from pressure.

## HINDFOOT CUSHION

The open celled, 2.8mm red SBR Memory in the heel area with its 12° Shore A runs out thinly at the edges and permits up to 3mm thick top covers. This softness has a dampening and pain relieving effect, as it absorbs impact forces.

## HEEL SPUR CUSHION PAD

Incorporated heel cushion pad made of 3mm yellow 7° Shore A Shock Absorber X PUR material to optimally reduce impact forces.







## WORKER

The WORKER line combines safety with high quality insole treatment. Designed to be used in work safety shoes, WORKER<sup>2</sup>, WORKER<sup>2</sup> CALCA, WORKER<sup>2</sup> RIGIDUS, WORKER<sup>2</sup> CPX, WORKER<sup>2</sup> Pro ELTEN, WORKER<sup>2</sup> CALCA ELTEN, WORKER<sup>2</sup> CPX ELTEN, WORKER<sup>2</sup> HAIX®, WORKER<sup>2</sup> CALCA HAIX® and WORKER<sup>2</sup> CPX HAIX® are your safe companions in your working day. Due to the anti-static properties of the surface, base materials and adhesives, they fulfil the ESD requirements and are type tested and approved according to European safety regulations with different safety shoe manufacturers' shoe models. The WORKER line's centrepiece is the orthotic shell made from the glass fiber composite material we developed and produce by ourselves in unisex widths. Due to its thermoplastic properties, it can be adapted to the foot simply and uniquely. High-quality and certified materials which meet Perpedes' high quality demands as well as the work safety requirements offer the opportunity to easily process and use the WORKER line.

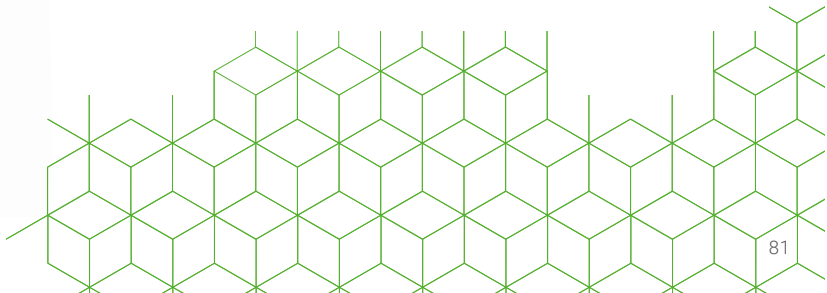

# WORKER<sup>2</sup> PRO

The WORKER<sup>2</sup> PRO orthotic blank forms the basis of the WORKER line and is specially designed for use in work safety shoes. The self-supporting Perpedes glass fiber composite shell with its flexible heel optimally supports the foot's longitudinal arch and maintains the natural gait pattern and walking sensation. The orthotic shell can be optionally shaped due to its thermoplastic

properties and can, therefore, be uniquely adapted to the user's foot and requirements. The combination with the WORKER<sup>2</sup> top cover, consisting of antistatic NetTex<sup>2</sup> and the ESD-conductive EVA foam, offers additional comfort and pain relief in inflexible, firm safety shoes. A soft, drop-shaped met pad made of Carbosan foam supports the transversal arch and relieves the forefoot area.



## CHARACTERISTICS

- Supportive foot orthotic blank
- Long-soled soft cushion (optional)
- Heel lift (optional)

## PRODUCT FACTS

- Size range: 35 - 48
- Width: Medium
- Foot orthotic shell: Acrylic composite material made of woven glass fiber and knitted polyamide (GH702)
- Outline: Square (Worker)
- 3D-Contour: N = moderate longitudinal arch support with slightly guided heel
- Special feature: Perforated forefoot area (if completely glued)  
Thin, flexible in heel area

## BESTSELLERS WORKER<sup>2</sup> PRO

ITEM NO. OLD	ITEM NO. NEW	BASE COVER	TOP COVER	MET PAD	WIDTH	LENGTH	SIZE RANGE	FINISHING STATUS
WPK1_	WOPRKA_	ESD EVA WORKER <sup>2</sup>	NetTex <sup>2</sup> Antistatic black	21388	Medium	4/4	35 - 48	completely glued
WPK2_	WOPRKB_	ESD EVA WORKER <sup>2</sup>	NetTex <sup>2</sup> Antistatic black, without transfer print	21388	Medium	4/4	35 - 48	completely glued
WPL1_	WOPRLA_	ESD EVA WORKER <sup>2</sup>	NetTex <sup>2</sup> Antistatic black	21388	Medium	4/4	35 - 48	non glued

## BASE/BOTTOM COVER

EVA ESD 30° Shore A, black

MATERIAL COMPOSITION  
100% EVA + Antistaticum

### CHARACTERISTICS

- Antistatic
- High resilience
- Disinfectable and washable surface

## TOP COVER

NetTex<sup>2</sup> Antistatic, black

MATERIAL COMPOSITION  
16% PES + 84% PUR

### CHARACTERISTICS

- Antistatic
- Very high abrasion resistance
- Antibacterial
- Breathable

## FOOT ORTHOTIC SHELL

Acrylic composite material made of woven glass fiber and knitted polyamide (GH702)

### CHARACTERISTICS

- Good thermalplastic processing at 130° - 140° C
- Optimal support of the foot's longitudinal arch

## HEEL AREA WITHOUT SHELL

Thin heel portion for a natural feeling for ground contact.

## MET PAD

The soft, drop-shaped met pad 21388 made of Carbosan foam supports the transversal arch and relieves the forefoot area.

## REINFORCING LAYER

An additional reinforcing layer provides smooth transitions and gives the orthotic blank further stability.

## HEEL CUSHION PAD

Heel cushion pad made of Carbosan foam to soften impact forces.



# WORKER<sup>2</sup> CALCA

After further processing by orthopedic technicians the WORKER<sup>2</sup> CALCA orthotic blank is specially suited to counteract chronically painful heel area complaints, e.g. plantar fasciitis or heel spurs, in work safety shoes. The particularly extensive, drop-shaped recess in the self-supporting Perpedes glass fiber composite shell is orientated on the plantar fascia's anatomical location and stretches to the foot's longitudinal arch. The moderate longitudinal arch support and the double layered red PUR Slow Memory foam in

the heel area have a dampening and impact relieving effect. The orthotic shell can be optionally shaped due to its thermoplastic properties and can, therefore, be uniquely adapted to the user's foot and requirements. The combination with the WORKER<sup>2</sup> top cover, consisting of antistatic NetTex<sup>2</sup> and the ESD-conductive EVA foam, offers additional comfort and pain relief in firm work safety shoes. A soft, drop-shaped met pad made of Carbosan foam supports the transversal arch and relieves the forefoot area.



## CHARACTERISTICS

- Supportive foot orthotic blank
- Calcaneal spur recess and cushion
- Long-soled soft cushion (optional)
- Heel lift (optional)

## PRODUCT FACTS

Size range:	35 - 48
Width:	Medium
Foot orthotic shell:	Acrylic composite material made of woven glass fiber and knitted polyamide (GH702)
Outline:	Square (Worker)
3D-Contour:	R = higher longitudinal arch support with guided heel
Special feature:	Perforated forefoot area (if completely glued) Anatomically correct recess for plantar fasciitis / heel spur

## BESTSELLERS WORKER<sup>2</sup> CALCA

ITEM NO. OLD	ITEM NO. NEW	BASE COVER	TOP COVER	MET PAD	WIDTH	LENGTH	SIZERANGE	FINISHING STATUS
WCK1_	WOCAKA_	ESD EVA WORKER <sup>2</sup>	NetTex <sup>2</sup> Antistatic black	21388	Medium	4/4	35 - 48	completely glued
WCK2_	WOCAKB_	ESD EVA WORKER <sup>2</sup>	NetTex <sup>2</sup> Antistatic black, without transfer print	21388	Medium	4/4	35 - 48	completely glued
WCL1_	WOCALA_	ESD EVA WORKER <sup>2</sup>	NetTex <sup>2</sup> Antistatic black	21388	Medium	4/4	35 - 48	non glued

## BASE/BOTTOM COVER

EVA ESD 30° Shore A, black

MATERIAL COMPOSITION  
100% EVA + Antistaticum

### CHARACTERISTICS

- Antistatic
- High resilience
- Disinfectable and washable surface

## FOOT ORTHOTIC SHELL

Acrylic composite material made of woven glass fiber and knitted polyamide (GH702)

### CHARACTERISTICS

- Good thermalplastic processing at 130° - 140° C
- Optimal support of the foot's longitudinal arch

## HEEL RECESS

The particularly extensive, drop-shaped heel recess provides the space for a shock absorbing heel pad and distributes the body load from the central Calcaneus to the lateral, usually pain-free areas of the heel.

## TOP COVER

NetTex<sup>2</sup> Antistatic, black

MATERIAL COMPOSITION  
16% PES + 84% PUR

### CHARACTERISTICS

- Antistatic
- Very high abrasion resistance
- Antibacterial
- Breathable

## MET PAD

The soft, drop-shaped met pad 21388 made of Carbosan foam supports the transversal arch and relieves the forefoot area.

## REINFORCING LAYER

An additional reinforcing layer provides smooth transitions and gives the orthotic blank further stability.

## HEEL CUSHION

The open celled, 3mm red PUR Slow Memory foam in the heel area with its 12° Shore A is used double layered in the shell's recess. This softness has a dampening and pain relieving effect, as it absorbs impact forces.



# WORKER<sup>2</sup> CPX

After further processing by orthopedic technicians the WORKER<sup>2</sup> CPX orthotic blank is specially suited to counteract acutely painful complaints due to overloading in the heel area, e.g. plantar fasciitis or Calcaneal spurs, in work safety shoes. The shell's heel recess in combination with the uniquely low positioning of the plantar fascia in the self-supporting Perpedes glass fiber composite shell is orientated on the fascia's anatomical location and stretches well within the foot's longitudinal arch. The moderate arch support and the double layered PUR Shock Absorber X

combined with the incorporated PUR Slow Memory cushioning material optimally reduce impact forces. The orthotic shell can be optionally shaped due to its thermoplastic properties and can, therefore, be uniquely adapted to the user's foot and requirements. The combination with the WORKER<sup>2</sup> top cover, consisting of antistatic NetTex<sup>2</sup> and the ESD-conductive EVA foam, offers additional comfort and pain relief in firm work safety shoes. A soft, drop-shaped met pad made of Carbosan foam supports the transversal arch and relieves the forefoot area.



## CHARACTERISTICS

- Supportive foot orthotic blank
- Calcaneal spur recess and cushion
- Long-soled soft cushion (optional)
- Heel lift (optional)

## PRODUCT FACTS

- Size range: 35 - 48
- Width: Medium
- Foot orthotic shell: Acrylic composite material made of woven glass fiber and knitted polyamide (GH702)
- Outline: Square (Worker)
- 3D-Contour: PX = moderate longitudinal arch support with plantar fascia groove in the shell
- Special feature: Perforated forefoot area (if completely glued)  
Anatomically correct recess for plantar fasciitis / heel spur with plantar fascia groove for maximum relief

## BESTSELLERS WORKER<sup>2</sup> CPX

ITEM NO. OLD	ITEM NO. NEW	BASE COVER	TOP COVER	MET PAD	WIDTH	LENGTH	SIZERANGE	FINISHING STATUS
WXX1_	WOCXKA_	ESD EVA WORKER <sup>2</sup>	NetTex <sup>2</sup> Antistatic black	21388	Medium	4/4	35 - 48	completely glued
WXX2_	WOCXKB_	ESD EVA WORKER <sup>2</sup>	NetTex <sup>2</sup> Antistatic black, without print transfer	21388	Medium	4/4	35 - 48	completely glued
WXL1_	WOCXLA_	ESD EVA WORKER <sup>2</sup>	NetTex <sup>2</sup> Antistatic black	21388	Medium	4/4	35 - 48	non glued

## BASE/BOTTOM COVER

EVA ESD 30° Shore A, black

MATERIAL COMPOSITION  
100% EVA + Antistaticum

### CHARACTERISTICS

- Antistatic
- High resilience
- Disinfectable and washable surface

## FOOT ORTHOTIC SHELL

Acrylic composite material made of woven glass fiber and knitted polyamide (GH702)

### CHARACTERISTICS

- Good thermalplastic processing at 130° - 140° C
- Optimal support of the foot's longitudinal arch

## HEEL RECESS WITH FASCIA GROOVE

The shell's anatomically correct heel recess in combination with the low positioning of the fascia runs well within the foot's longitudinal arch. The heel recess provides the space for a shock absorbing heel pad and distributes the body load from the central Calcaneus to the lateral, usually pain-free areas of the heel.

## TOP COVER

NetTex<sup>2</sup> Antistatic, black

MATERIAL COMPOSITION  
16% PES + 84% PUR

### CHARACTERISTICS

- Antistatic
- Very high abrasion resistance
- Antibacterial
- Breathable

## MET PAD

The soft, drop-shaped met pad 21388 made of Carbosan foam supports the transversal arch and relieves the forefoot area.

## REINFORCING LAYER

An additional reinforcing layer provides smooth transitions and gives the orthotic blank further stability.

## HINDFOOT CUSHION

The open celled, 3mm yellow Shock Absorber X PUR foam in the heel area with its 7° Shore A is double layered in the shell's recess. This softness has a dampening and pain relieving effect, as it effectively absorbs impact forces.



# WORKER<sup>2</sup> RIGIDUS

After further processing by orthopedic technicians the WORKER<sup>2</sup> RIGIDUS orthotic blank is specially suited for use with complaints in the big toe area, e.g. in the case of Hallux limitus, in work safety shoes. The self-supporting Perpedes glass fiber composite shell with its short wing section dynamically supports the foot's longitudinal arch and is extended under the MTP joint 1 in such a way, that the joint is spared from painful movement-related deflections whilst walking. The orthotic shell can be optionally shaped due to

its thermoplastic properties and can, therefore, be uniquely adapted to the user's foot and requirements. The combination with the WORKER<sup>2</sup> top cover, consisting of antistatic NetTex<sup>2</sup> and the ESD-conductive EVA foam, offers additional comfort and pain relief in firm work safety shoes. A soft, drop-shaped met pad made of Carbosan foam supports the transversal arch and relieves the forefoot area.



## CHARACTERISTICS

- Supportive foot orthotic blank
- Rigidus splint
- Long-soled soft cushion (optional)
- Heel lift (optional)

## PRODUCT FACTS

- Size range: 35 - 48
- Width: Medium
- Foot orthotic shell: Acrylic composite material made of knitted glass fiber (G431)
- Outline: Square (Worker)
- 3D-Contour: N = moderate longitudinal arch support with slightly guided heel
- Special feature: Perforated forefoot area (if completely glued)  
Shell recess in heel area in combination with rigidus splint

## BESTSELLERS WORKER<sup>2</sup> RIGIDUS

ITEM NO. <b>OLD</b>	ITEM NO. <b>NEW</b>	BASE COVER	TOP COVER	MET PAD	WIDTH	LENGTH	SIZERANGE	FINISHING STATUS
WRK1_	WORIKA_	ESD EVA WORKER <sup>2</sup>	NetTex <sup>2</sup> Antistatic black	21388	Medium	4/4	35 - 48	completely glued
WRK2_	WORIKB_	ESD EVA WORKER <sup>2</sup>	NetTex <sup>2</sup> Antistatic black, without transfer print	21388	Medium	4/4	35 - 48	completely glued
WRL1_	WORILA_	ESD EVA WORKER <sup>2</sup>	NetTex <sup>2</sup> Antistatic black	21388	Medium	4/4	35 - 48	non glued

## BASE/BOTTOM COVER

EVA ESD 30° Shore A, black

MATERIAL COMPOSITION  
100% EVA + Antistaticum

### CHARACTERISTICS

- Antistatic
- High resilience
- Disinfectable and washable surface

## RIGIDUS SPLINT

Rigidus splint for motion-limiting reinforcement underneath the MTP-joint I

## FOOT ORTHOTIC SHELL

Acrylic composite material made of woven glass fiber and knitted polyamide (GH702)

### CHARACTERISTICS

Good thermalplastic processing at 130° - 140° C  
Optimal support of the foot's longitudinal arch

## HEEL AREA WITHOUT SHELL

Thin heel portion for a natural feeling for ground contact.

## TOP COVER

NetTex<sup>2</sup> Antistatic, black

MATERIAL COMPOSITION  
16% PES + 84% PUR

### CHARACTERISTICS

- Antistatic
- Very high abrasion resistance
- Antibacterial
- Breathable

## MET PAD

The soft, drop-shaped met pad 21388 made of Carbosan foam supports the transversal arch and relieves the forefoot area.

## REINFORCING LAYER

An additional reinforcing layer provides smooth transitions and gives the orthotic blank further stability.

## HEEL CUSHION PAD

Heel cushion pad made of Carbosan foam to soften impact forces.



# WORKER<sup>2</sup> PRO ELTEN

The WORKER<sup>2</sup> PRO ELTEN orthotic blank forms the basis of the WORKER line and is specially designed for use in work safety shoes. The self-supporting Perpedes glass fiber composite shell with its flexible heel optimally supports the foot's longitudinal arch and maintains the natural gait pattern and walking sensation. The orthotic shell can be optionally shaped due to its thermoplastic

properties and can, therefore, be uniquely adapted to the user's foot and requirements. The ELTEN ESD Pro material, consisting of microfiber in combination with the soft PUR foam, offers comfort in work safety shoes. A soft, drop-shaped met pad made of Carbosan foam supports the transversal arch and relieves the forefoot area.



WORKER<sup>2</sup> PRO ELTEN  
WOPRKC\_

## CHARACTERISTICS

- Supportive foot orthotic blank
- Long-soled soft cushion (optional)
- Heel lift (optional)

## PRODUCT FACTS

Size range:	35 - 48
Width:	Medium
Foot orthotic shell:	Acrylic composite material made of woven glass fiber and knitted polyamide (GH702)
Outline:	Square (Worker)
3D-Contour:	N = moderate longitudinal arch support with slightly guided heel
Special feature:	Thin, flexible in heel area

## BESTSELLERS WORKER<sup>2</sup> PRO ELTEN

ITEM NO.	BASE COVER	TOP COVER	MET PAD	WIDTH	LENGTH	SIZE RANGE	FINISHING STATUS
WOPRKC_	EVA ESD black	ELTEN ESD Pro	21388	Medium	4/4	35 - 48	completely glued
WBPR_	EVA ESD black	-	-	Medium	3/4	-	non glued*

\*According to DGUV 112 - 191 only in connection with cover GA01, GA02, GA03, GA04

## BASE/BOTTOM COVER

EVA ESD black, 55° Shore A, 1.5 mm

### CHARACTERISTICS

- Antistatic
- Disinfectable and washable surface

## FOOT ORTHOTIC SHELL

Acrylic composite material made of woven glass fiber and knitted polyamide (GH702)

### CHARACTERISTICS

- Good thermalplastic processing at 130° - 140° C
- Optimal support of the foot's longitudinal arch

## HEEL AREA WITHOUT SHELL

Thin heel portion for a natural feeling for ground contact.

## TOP COVER

ELTEN ESD Pro

ELTEN Logo + PU foam black, 35° Shore A, 2.0 mm

### CHARACTERISTICS

- Very good moisture absorption and release
- Abrasion resistant
- Odor control through activated carbon absorbers in the foam

## MET PAD

The soft, drop-shaped met pad 21388 made of Carbosan foam supports the transversal arch and relieves the forefoot area.

## REINFORCING LAYER

An additional reinforcing layer provides smooth transitions and gives the orthotic blank further stability.

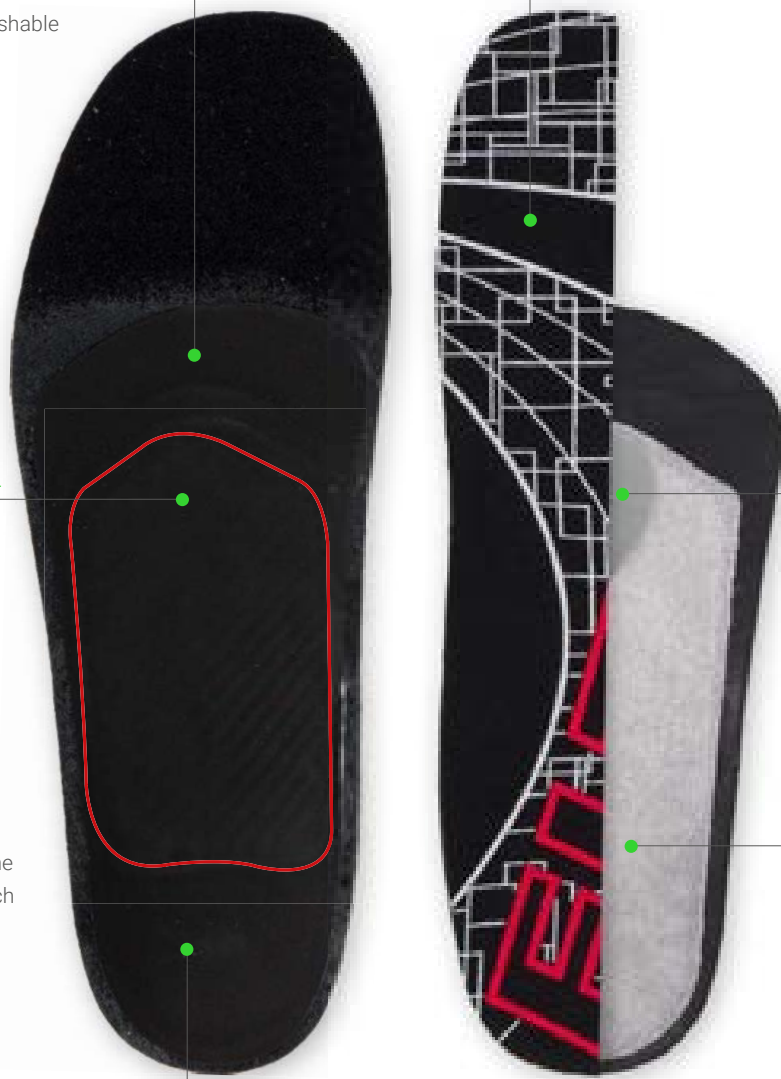

# WORKER<sup>2</sup> CALCA ELTEN

After further processing by orthopedic technicians the WORKER<sup>2</sup> CALCA ELTEN orthotic blank is specially suited to counteract chronically painful heel area complaints, e.g. plantar fasciitis or heel spurs, in work safety shoes. The particularly extensive, drop-shaped recess in the self-supporting Perpedes glass fiber composite shell is orientated on the plantar fascia's anatomical location and stretches to the foot's longitudinal arch. The moderate longitudinal arch support and the double layered red PUR Slow Memory foam in the heel

area have a dampening and impact relieving effect. The orthotic shell can be optionally shaped due to its thermoplastic properties and can, therefore, be uniquely adapted to the user's foot and requirements. The ELTEN ESD Pro material, consisting of microfiber in combination with the soft PUR foam, offers comfort in work safety shoes. A soft, drop-shaped met pad made of Carbosan foam supports the transversal arch and relieves the forefoot area.



WORKER<sup>2</sup> CALCA ELTEN  
WOCAKC\_

## CHARACTERISTICS

- Supportive foot orthotic blank
- Calcaneal spur recess and cushion
- Long-soled soft cushion (optional)
- Heel lift (optional)

## PRODUCT FACTS

Size range:	35 - 48
Width:	Medium
Foot orthotic shell:	Acrylic composite material made of woven glass fiber and knitted polyamide (GH702)
Outline:	Square (Worker)
3D-Contour:	R = higher longitudinal arch support with guided heel
Special feature:	Anatomically correct recess for plantar fasciitis / heel spur

## BESTSELLERS WORKER<sup>2</sup> CALCA ELTEN

ITEM NO.	BASE COVER	TOP COVER	MET PAD	WIDTH	LENGTH	SIZE RANGE	FINISHING STATUS
WOCAKC_	EVA ESD black	ELTEN ESD Pro	21388	Medium	4/4	35 - 48	completely glued
WBCA_	EVA ESD black	-	-	Medium	3/4	-	non glued*

\*According to DGUV 112 - 191 only in connection with cover GA01, GA02, GA03, GA04

### BASE/BOTTOM COVER

EVA ESD black, 55° Shore A, 1.5 mm

#### CHARACTERISTICS

- Antistatic
- Disinfectable and washable surface

### FOOT ORTHOTIC SHELL

Acrylic composite material made of woven glass fiber and knitted polyamide (GH702)

#### CHARACTERISTICS

- Good thermalplastic processing at 130° - 140° C
- Optimal support of the foot's longitudinal arch

### HEEL RECESS

The particularly extensive, drop-shaped heel recess provides the space for a shock absorbing heel pad and distributes the body load from the central Calcaneus to the lateral, usually pain-free areas of the heel.

### TOP COVER

ELTEN ESD Pro

ELTEN Logo + PU foam black, 35° Shore A, 2.0 mm

#### CHARACTERISTICS

- Very good moisture absorption and release
- Abrasion resistant
- Odor control through activated carbon absorbers in the foam

### MET PAD

The soft, drop-shaped met pad 21388 made of Carbosan foam supports the transversal arch and relieves the forefoot area.

### REINFORCING LAYER

An additional reinforcing layer provides smooth transitions and gives the orthotic blank further stability.

### HINDFOOT CUSHION

The open celled, 3mm red PUR Slow Memory foam in the heel area with its 12° Shore A is used double layered in the shell's recess. This softness has a dampening and pain relieving effect, as it absorbs impact forces.



# WORKER<sup>2</sup> CPX ELTEN

After further processing by orthopedic technicians the WORKER<sup>2</sup> CPX ELTEN orthotic blank is specially suited to counteract acutely painful complaints due to overloading in the heel area, e.g. plantar fasciitis or Calcaneal spurs, in work safety shoes. The shell's heel recess in combination with the uniquely low positioning of the plantar fascia in the self-supporting Perpedes glass fiber composite shell is orientated on the fascia's anatomical location and stretches well within the foot's longitudinal arch. The moderate arch support and the double layered PUR Shock Absorber X

combined with the incorporated PUR Slow Memory cushioning material optimally reduce impact forces. The orthotic shell can be optionally shaped due to its thermoplastic properties and can, therefore, be uniquely adapted to the user's foot and requirements. The ELTEN ESD Pro material, consisting of microfiber in combination with the soft PUR foam, offers comfort in work safety shoes. A soft, drop-shaped met pad made of Carbosan foam supports the transversal arch and relieves the forefoot area.



WORKER<sup>2</sup> CPX ELTEN  
WOCXKC\_

## CHARACTERISTICS

- Supportive foot orthotic blank
- Calcaneal spur recess and cushion
- Long-soled soft cushion (optional)
- Heel lift (optional)

## PRODUCT FACTS

Size range:	35 - 48
Width:	Medium
Foot orthotic shell:	Acrylic composite material made of woven glass fiber and knitted polyamide (GH702)
Outline:	Square (Worker)
3D-Contour:	PX = moderate longitudinal arch support with plantar fascia groove in the shell
Special feature:	Anatomically correct recess for plantar fasciitis / heel spur with plantar fascia groove for maximum relief

## BESTSELLERS WORKER<sup>2</sup> CPX ELTEN

ITEM NO.	BASE COVER	TOP COVER	MET PAD	WIDTH	LENGTH	SIZE RANGE	FINISHING STATUS
WOCXKC_	EVA ESD black	ELTEN ESD Pro	21388	Medium	4/4	35 - 48	completely glued
WBCX_	EVA ESD black	-	-	Medium	3/4	-	non glued*

\*According to DGUV 112 - 191 only in connection with cover GA01, GA02, GA03, GA04

## BASE/BOTTOM COVER

EVA ESD black, 55° Shore A, 1.5 mm

### CHARACTERISTICS

- Antistatic
- Disinfectable and washable surface

## FOOT ORTHOTIC SHELL

Acrylic composite material made of woven glass fiber and knitted polyamide (GH702)

### CHARACTERISTICS

- Good thermalplastic processing at 130° - 140° C
- Optimal support of the foot's longitudinal arch

## HEEL RECESS WITH FASCIA GROOVE

The shell's anatomically correct heel recess in combination with the low positioning of the fascia runs well within the foot's longitudinal arch. The heel recess provides the space for a shock absorbing heel pad and distributes the body load from the central Calcaneus to the lateral, usually pain-free areas of the heel.

## TOP COVER

ELTEN ESD Pro

ELTEN Logo + PU foam black, 35° Shore A, 2.0 mm

### CHARACTERISTICS

- Very good moisture absorption and release
- Abrasion resistant
- Odor control through activated carbon absorbers in the foam

## MET PAD

The soft, drop-shaped met pad 21388 made of Carbosan foam supports the transversal arch and relieves the forefoot area.

## REINFORCING LAYER

An additional reinforcing layer provides smooth transitions and gives the orthotic blank further stability.

## HINDFOOT CUSHION

The open celled, 3mm yellow Shock Absorber X PUR foam in the heel area with its 7° Shore A is double layered in the shell's recess. This softness has a dampening and pain relieving effect, as it effectively absorbs impact forces.

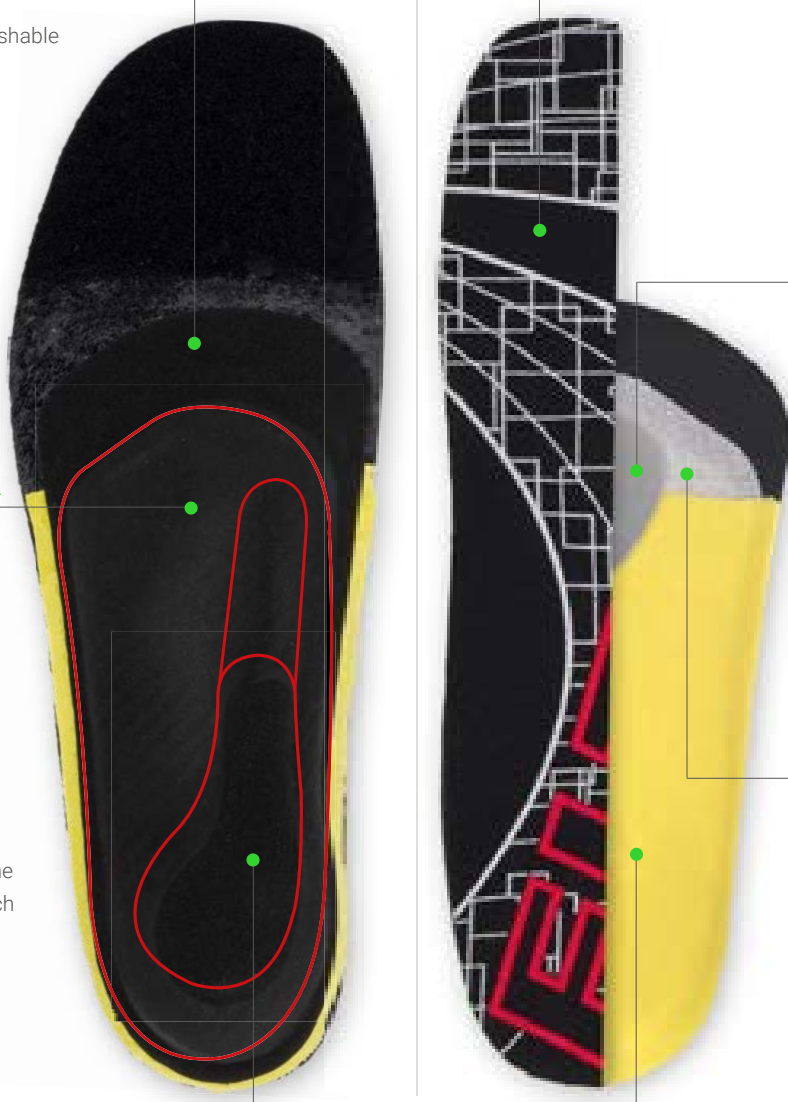

# WORKER<sup>2</sup> PRO HAIX<sup>®</sup>

The WORKER<sup>2</sup> PRO HAIX<sup>®</sup> orthotic blank forms the basis of the WORKER line and is specially designed for use in work safety shoes. The self-supporting Perpedes glass fiber composite shell with its flexible heel optimally supports the foot's longitudinal arch and maintains the natural gait pattern and walking sensation. The orthotic shell can be optionally shaped due to its thermoplastic

properties and can, therefore, be uniquely adapted to the user's foot and requirements. The HAIX<sup>®</sup> CO system, consisting of 100% polyester fabric in combination with the soft PUR foam, offers comfort in work safety shoes. A soft, drop-shaped met pad made of Carbosan foam supports the transversal arch and relieves the forefoot area.



WORKER<sup>2</sup> PRO HAIX<sup>®</sup>  
WOPRKD\_

## CHARACTERISTICS

- Supportive foot orthotic blank
- Long-soled soft cushion (optional)
- Heel lift (optional)

## PRODUCT FACTS

Size range:	35 - 48
Width:	Medium
Foot orthotic shell:	Acrylic composite material made of woven glass fiber and knitted polyamide (GH702)
Outline:	Square (Worker)
3D-Contour:	N = moderate longitudinal arch support with slightly guided heel
Special feature:	Thin, flexible in heel area

## BESTSELLER WORKER<sup>2</sup> PRO HAIX<sup>®</sup>

ITEM NO.	BASE COVER	TOP COVER	MET PAD	WIDTH	LENGTH	SIZE RANGE	FINISHING STATUS
WOPRKD_	EVA ESD black	HAIX <sup>®</sup> CO system	21388	Medium	4/4	35 - 48	completely glued
WBPR_	EVA ESD black	-	-	Medium	3/4	-	non glued*

\*According to DGUV 112 - 191 only in connection with cover GA01, GA02, GA03, GA04

## BASE/BOTTOM COVER

EVA ESD black, 55° Shore A, 1.5 mm

### CHARACTERISTICS

- Antistatic
- Disinfectable and washable surface

## FOOT ORTHOTIC SHELL

Acrylic composite material made of woven glass fiber and knitted polyamide (GH702)

### CHARACTERISTICS

- Good thermalplastic processing at 130° - 140° C
- Optimal support of the foot's longitudinal arch

## HEEL AREA WITHOUT SHELL

Thin heel portion for a natural feeling for ground contact.

## TOP COVER

HAIX® CO system

HAIX® Logo + PU foam green, 35° Shore A, 4.0 mm

### CHARACTERISTICS

- High moisture absorption
- Very good cushioning

## MET PAD

The soft, drop-shaped met pad 21388 made of Carbosan foam supports the transversal arch and relieves the forefoot area.

## REINFORCING LAYER

An additional reinforcing layer provides smooth transitions and gives the orthotic blank further stability.



# WORKER<sup>2</sup> CALCA HAIX<sup>®</sup>

After further processing by orthopedic technicians the WORKER<sup>2</sup> CALCA HAIX<sup>®</sup> orthotic blank is specially suited to counteract chronically painful heel area complaints, e.g. plantar fasciitis or heel spurs, in work safety shoes. The particularly extensive, drop-shaped recess in the self-supporting Perpedes glass fiber composite shell is orientated on the plantar fascia's anatomical location and stretches to the foot's longitudinal arch. The moderate longitudinal arch support and the double layered red PUR Slow Memory foam in

the heel area have a dampening and impact relieving effect. The orthotic shell can be optionally shaped due to its thermoplastic properties and can, therefore, be uniquely adapted to the user's foot and requirements. The HAIX<sup>®</sup> CO system, consisting of 100% polyester fabric in combination with the soft PUR foam, offers comfort in work safety shoes. A soft, drop-shaped met pad made of Carbosan foam supports the transversal arch and relieves the forefoot area.



WORKER<sup>2</sup> CALCA HAIX<sup>®</sup>  
WOCAKD\_

## CHARACTERISTICS

- Supportive foot orthotic blank
- Calcaneal spur recess and cushion
- Long-soled soft cushion (optional)
- Heel lift (optional)

## PRODUCT FACTS

Size range:	35 - 48
Width:	Medium
Foot orthotic shell:	Acrylic composite material made of woven glass fiber and knitted polyamide (GH702)
Outline:	Square (Worker)
3D-Contour:	R = higher longitudinal arch support with guided heel
Special feature:	Anatomically correct recess for plantar fasciitis / heel spur

## BESTSELLERS WORKER<sup>2</sup> CALCA HAIX<sup>®</sup>

ITEM NO.	BASE COVER	TOP COVER	MET PAD	WIDTH	LENGTH	SIZE RANGE	FINISHING STATUS
WOCAKD_	EVA ESD black	HAIX <sup>®</sup> CO system	21388	Medium	4/4	35 - 48	completely glued
WBCA_	EVA ESD black		-	Medium-	3/4	-	non glued*

\*According to DGUV 112 - 191 only in connection with cover GA01, GA02, GA03, GA04

### BASE/BOTTOM COVER

EVA ESD black, 55° Shore A, 1.5 mm

#### CHARACTERISTICS

- Antistatic
- Disinfectable and washable surface

### FOOT ORTHOTIC SHELL

Acrylic composite material made of woven glass fiber and knitted polyamide (GH702)

#### CHARACTERISTICS

- Good thermalplastic processing at 130° - 140° C
- Optimal support of the foot's longitudinal arch

### HEEL RECESS

The particularly extensive, drop-shaped heel recess provides the space for a shock absorbing heel pad and distributes the body load from the central Calcaneus to the lateral, usually pain-free areas of the heel.

### TOP COVER

HAIX® CO system

HAIX® Logo + PU foam green, 35° Shore A, 4.0 mm

#### CHARACTERISTICS

- High moisture absorption
- Very good cushioning

### MET PAD

The soft, drop-shaped met pad 21388 made of Carbosan foam supports the transversal arch and relieves the forefoot area.

### REINFORCING LAYER

An additional reinforcing layer provides smooth transitions and gives the orthotic blank further stability.

### HINDFOOT CUSHION

The open celled, 3mm red PUR Slow Memory foam in the heel area with its 12° Shore A is used double layered in the shell's recess. This softness has a dampening and pain relieving effect, as it absorbs impact forces.



# WORKER<sup>2</sup> CPX HAIX<sup>®</sup>

After further processing by orthopedic technicians the WORKER<sup>2</sup> CPX HAIX<sup>®</sup> orthotic blank is specially suited to counteract acutely painful complaints due to overloading in the heel area, e.g. plantar fasciitis or Calcaneal spurs, in work safety shoes. The shell's heel recess in combination with the uniquely low positioning of the plantar fascia in the self-supporting Perpedes glass fiber composite shell is orientated on the fascia's anatomical location and stretches well within the foot's longitudinal arch. The moderate arch support and the double layered PUR Shock Absorber X

combined with the incorporated PUR Slow Memory cushioning material optimally reduce impact forces. The orthotic shell can be optionally shaped due to its thermoplastic properties and can, therefore, be uniquely adapted to the user's foot and requirements. The HAIX<sup>®</sup> CO system, consisting of 100% polyester fabric in combination with the soft PUR foam, offers comfort in work safety shoes. A soft, drop-shaped met pad made of Carbosan foam supports the transversal arch and relieves the forefoot area.



WORKER<sup>2</sup> CPX HAIX<sup>®</sup>  
WOCXKD\_

## CHARACTERISTICS

- Supportive foot orthotic blank
- Calcaneal spur recess and cushion
- Long-soled soft cushion (optional)
- Heel lift (optional)

## PRODUCT FACTS

Size range:	35 - 48
Width:	Medium
Foot orthotic shell:	Acrylic composite material made of woven glass fiber and knitted polyamide (GH702)
Outline:	Square (Worker)
3D-Contour:	PX = moderate longitudinal arch support with plantar fascia groove in the shell
Special feature:	Anatomically correct recess for plantar fasciitis / heel spur with plantar fascia groove for maximum relief

## BESTSELLERS WORKER<sup>2</sup> CPX HAIX<sup>®</sup>

ITEM NO.	BASE COVER	TOP COVER	MET PAD	WIDTH	LENGTH	SIZE RANGE	FINISHING STATUS
WOCXKD_	EVA ESD black	HAIX <sup>®</sup> CO system	21388	Medium	4/4	35 - 48	completely glued
WBCX_	EVA ESD black	-	-	Medium	3/4	-	non glued*

\*According to DGUV 112 - 191 only in connection with cover GA01, GA02, GA03, GA04

## BASE/BOTTOM COVER

EVA ESD black, 55° Shore A, 1.5 mm

### CHARACTERISTICS

- Antistatic
- Disinfectable and washable surface

## FOOT ORTHOTIC SHELL

Acrylic composite material made of woven glass fiber and knitted polyamide (GH702)

### CHARACTERISTICS

- Good thermalplastic processing at 130° - 140° C
- Optimal support of the foot's longitudinal arch

## HEEL RECESS WITH FASCIA GROOVE

The shell's anatomically correct heel recess in combination with the low positioning of the fascia runs well within the foot's longitudinal arch. The heel recess provides the space for a shock absorbing heel pad and distributes the body load from the central Calcaneus to the lateral, usually pain-free areas of the heel.

## TOP COVER

HAIX® CO system

HAIX® Logo + PU foam green, 35° Shore A, 4.0 mm

### CHARACTERISTICS

- High moisture absorption
- Very good cushioning

## MET PAD

The soft, drop-shaped met pad 21388 made of Carbosan foam supports the transversal arch and relieves the forefoot area.

## REINFORCING LAYER

An additional reinforcing layer provides smooth transitions and gives the orthotic blank further stability.

## HINDFOOT CUSHION

The open celled, 3mm yellow Shock Absorber X PUR foam in the heel area with its 7° Shore A is double layered in the shell's recess. This softness has a dampening and pain relieving effect, as it effectively absorbs impact forces.



# WORKER<sup>2</sup> PRO ATLAS

The WORKER<sup>2</sup> PRO ATLAS orthotic blank forms the basis of the WORKER line and is specially designed for use in work safety shoes. The self-supporting Perpedes glass fiber composite shell with its flexible heel optimally supports the foot's longitudinal arch and maintains the natural gait pattern and walking sensation. The orthotic shell can be optionally shaped due to its thermoplastic

properties and can, therefore, be uniquely adapted to the user's foot and requirements. The ATLAS KLIMA-KOMFORT<sup>®</sup> material, consisting of microfiber in combination with the soft PUR foam, offers comfort in work safety shoes. A soft, drop-shaped met pad made of Carbosan foam supports the transversal arch and relieves the forefoot area.



WORKER<sup>1</sup> PRO ATLAS

WOPRKF\_

## CHARACTERISTICS

- Supportive foot orthotic blank
- Long-soled soft cushion (optional)
- Heel lift (optional)

## PRODUCT FACTS

Size range:	35 - 48
Width:	Medium
Foot orthotic shell:	Acrylic composite material made of woven glass fiber and knitted polyamide (GH702)
Outline:	Square (Worker)
3D-Contour:	N = moderate longitudinal arch support with slightly guided heel
Special feature:	Thin, flexible in heel area

## BESTSELLERS WORKER<sup>2</sup> PRO ATLAS

ITEM NO.	BASE COVER	TOP COVER	MET PAD	WIDTH	LENGTH	SIZE RANGE	FINISHING STATUS
WOPRKF_	EVA ESD black	ATLAS KLIMA-KOMFORT <sup>®</sup>	21388	Medium	4/4	35 - 48	completely glued
WBPR_	EVA ESD black	-	-	Medium	3/4	-	non glued*

\*According to DGUV 112 - 191 only in connection with cover GA01, GA02, GA03, GA04

### BASE/BOTTOM COVER

EVA ESD black, 55° Shore A, 1.5 mm

#### CHARACTERISTICS

- Antistatic
- Disinfectable and washable surface

### FOOT ORTHOTIC SHELL

Acrylic composite material made of woven glass fiber and knitted polyamide (GH702)

#### CHARACTERISTICS

- Good thermalplastic processing at 130° - 140° C
- Optimal support of the foot's longitudinal arch

### HEEL AREA WITHOUT SHELL

Thin heel portion for a natural feeling for ground contact.



### TOP COVER

ATLAS KLIMA-KOMFORT®  
ATLAS Logo + PU foam black,  
15° Shore A, 2.5 mm

#### CHARACTERISTICS

- Very good moisture absorption and release
- Abrasion resistant
- Odor control through activated carbon absorbers in the foam



### MET PAD

The soft, drop-shaped met pad 21388 made of Carbosan foam supports the transversal arch and relieves the forefoot area.

### REINFORCING LAYER

An additional reinforcing layer provides smooth transitions and gives the orthotic blank further stability.

# WORKER<sup>2</sup> CALCA ATLAS

After further processing by orthopedic technicians the WORKER<sup>2</sup> CALCA ATLAS orthotic blank is specially suited to counteract chronically painful heel area complaints, e.g. plantar fasciitis or heel spurs, in work safety shoes. The particularly extensive, drop-shaped recess in the self-supporting Perpedes glass fiber composite shell is orientated on the plantar fascia's anatomical location and stretches to the foot's longitudinal arch. The moderate longitudinal arch support and the double layered red PUR Slow Memory foam in

the heel area have a dampening and impact relieving effect. The orthotic shell can be optionally shaped due to its thermoplastic properties and can, therefore, be uniquely adapted to the user's foot and requirements. The ATLAS KLIMA-KOMFORT<sup>®</sup> material, consisting of microfiber in combination with the soft PUR foam, offers comfort in work safety shoes. A soft, drop-shaped met pad made of Carbosan foam supports the transversal arch and relieves the forefoot area.



WORKER<sup>2</sup> CALCA ATLAS  
WOCKAF\_

## CHARACTERISTICS

- Supportive foot orthotic blank
- Calcaneal spur recess and cushion
- Long-soled soft cushion (optional)
- Heel lift (optional)

## PRODUCT FACTS

- Size range: 35 - 48  
 Width: Medium  
 Foot orthotic shell: Acrylic composite material made of woven glass fiber and knitted polyamide (GH702)  
 Outline: Square (Worker)  
 3D-Contour: R = higher longitudinal arch support with guided heel  
 Special feature: Anatomically correct recess for plantar fasciitis / heel spur

## BESTSELLERS WORKER<sup>2</sup> CALCA ATLAS

ITEM NO.	BASE COVER	TOP COVER	MET PAD	WIDTH	LENGTH	SIZE RANGE	FINISHING STATUS
WOCKAF_	EVA ESD black	ATLAS KLIMA-KOMFORT <sup>®</sup>	21388	Medium	4/4	35 - 48	completely glued
WBCA_	EVA ESD black		-	Medium-	3/4	-	non glued*

\*According to DGUV 112 - 191 only in connection with cover GA01, GA02, GA03, GA04

### BASE/BOTTOM COVER

EVA ESD black, 55° Shore A, 1.5 mm

#### CHARACTERISTICS

- Antistatic
- Disinfectable and washable surface

### FOOT ORTHOTIC SHELL

Acrylic composite material made of woven glass fiber and knitted polyamide (GH702)

#### CHARACTERISTICS

- Good thermalplastic processing at 130° - 140° C
- Optimal support of the foot's longitudinal arch

### HEEL RECESS

The particularly extensive, drop-shaped heel recess provides the space for a shock absorbing heel pad and distributes the body load from the central Calcaneus to the lateral, usually pain-free areas of the heel.

### TOP COVER

ATLAS KLIMA-KOMFORT®

ATLAS Logo + PU foam black, 15° Shore A, 2.5 mm

#### CHARACTERISTICS

- Very good moisture absorption and release
- Abrasion resistant
- Odor control through activated carbon absorbers in the foam

### MET PAD

The soft, drop-shaped met pad 21388 made of Carbosan foam supports the transversal arch and relieves the forefoot area.

### REINFORCING LAYER

An additional reinforcing layer provides smooth transitions and gives the orthotic blank further stability.

### HINDFOOT CUSHION

The open celled, 3mm red PUR Slow Memory foam in the heel area with its 12° Shore A is used double layered in the shell's recess. This softness has a dampening and pain relieving effect, as it absorbs impact forces.



# WORKER<sup>2</sup> CPX ATLAS

After further processing by orthopedic technicians the WORKER<sup>2</sup> CPX ATLAS orthotic blank is specially suited to counteract acutely painful complaints due to overloading in the heel area, e.g. plantar fasciitis or Calcaneal spurs, in work safety shoes. The shell's heel recess in combination with the uniquely low positioning of the plantar fascia in the self-supporting Perpedes glass fiber composite shell is orientated on the fascia's anatomical location and stretches well within the foot's longitudinal arch. The moderate arch support and the double layered PUR Shock Absorber X

combined with the incorporated PUR Slow Memory cushioning material optimally reduce impact forces. The orthotic shell can be optionally shaped due to its thermoplastic properties and can, therefore, be uniquely adapted to the user's foot and requirements. The ATLAS KLIMA-KOMFORT® material, consisting of microfiber in combination with the soft PUR foam, offers comfort in work safety shoes. A soft, drop-shaped met pad made of Carbosan foam supports the transversal arch and relieves the forefoot area.



WORKER<sup>1</sup> CPX ATLAS  
WOCXKF\_

## CHARACTERISTICS

- Supportive foot orthotic blank
- Calcaneal spur recess and cushion
- Long-soled soft cushion (optional)
- Heel lift (optional)

## PRODUCT FACTS

Size range: 35 - 48  
 Width: Medium  
 Foot orthotic shell: Acrylic composite material made of woven glass fiber and knitted polyamide (GH702)  
 Outline: Square (Worker)  
 3D-Contour: PX = moderate longitudinal arch support with plantar fascia groove in the shell  
 Special feature: Anatomically correct recess for plantar fasciitis / heel spur with plantar fascia groove for maximum relief

## BESTSELLERS WORKER<sup>2</sup> CPX ATLAS

ITEM NO.	BASE COVER	TOP COVER	MET PAD	WIDTH	LENGTH	SIZE RANGE	FINISHING STATUS
WOCXKF_	EVA ESD black	ATLAS KLIMA-KOMFORT®	21388	Medium	4/4	35 - 48	completely glued
WBCX_	EVA ESD black	-	-	Medium	3/4	-	non glued*

\*According to DGUV 112 - 191 only in connection with cover GA01, GA02, GA03, GA04

### BASE/BOTTOM COVER

EVA ESD black, 55° Shore A, 1.5 mm

#### CHARACTERISTICS

- Antistatic
- Disinfectable and washable surface

### FOOT ORTHOTIC SHELL

Acrylic composite material made of woven glass fiber and knitted polyamide (GH702)

#### CHARACTERISTICS

- Good thermalplastic processing at 130° - 140° C
- Optimal support of the foot's longitudinal arch

### HEEL RECESS WITH FASCIA GROOVE

The shell's anatomically correct heel recess in combination with the low positioning of the fascia runs well within the foot's longitudinal arch. The heel recess provides the space for a shock absorbing heel pad and distributes the body load from the central Calcaneus to the lateral, usually pain-free areas of the heel.

### TOP COVER

ATLAS KLIMA-KOMFORT®  
ATLAS Logo + PU foam black, 15° Shore A, 2.5 mm

#### CHARACTERISTICS

- Very good moisture absorption and release
- Abrasion resistant
- Odor control through activated carbon absorbers in the foam

### MET PAD

The soft, drop-shaped met pad 21388 made of Carbosan foam supports the transversal arch and relieves the forefoot area.

### REINFORCING LAYER

An additional reinforcing layer provides smooth transitions and gives the orthotic blank further stability.

### HINDFOOT CUSHION

The open celled, 3mm yellow Shock Absorber X PUR foam in the heel area with its 7° Shore A is double layered in the shell's recess. This softness has a dampening and pain relieving effect, as it effectively absorbs impact forces.



# WORKER<sup>2</sup> PRO STEITZ SECURA

The WORKER<sup>2</sup> PRO STEITZ SECURA orthotic blank forms the basis of the WORKER line and is specially designed for use in work safety shoes. The self-supporting Perpedes glass fiber composite shell with its flexible heel optimally supports the foot's longitudinal arch and maintains the natural gait pattern and walking sensation. The orthotic shell can be optionally shaped due to its thermoplas-

tic properties and can, therefore, be uniquely adapted to the user's foot and requirements. The STEITZ SECURA ESD material, consisting of microfiber in combination with the soft PUR foam, offers comfort in work safety shoes. A soft, drop-shaped met pad made of Carbosan foam supports the transversal arch and relieves the forefoot area.



WORKER<sup>2</sup> PRO STEITZ SECURA  
WOPRKE\_

## CHARACTERISTICS

- Supportive foot orthotic blank
- Long-soled soft cushion (optional)
- Heel lift (optional)

## PRODUCT FACTS

Size range: 35 - 48  
 Width: Medium  
 Foot orthotic shell: Acrylic composite material made of woven glass fiber and knitted polyamide (GH702)  
 Outline: Square (Worker)  
 3D-Contour: N = moderate longitudinal arch support with slightly guided heel  
 Special feature: Thin, flexible in heel area

## BESTSELLERS WORKER<sup>2</sup> PRO STEITZ SECURA

ITEM NO.	BASE COVER	TOP COVER	MET PAD	WIDTH	LENGTH	SIZE RANGE	FINISHING STATUS
WOPRKE_	EVA ESD black	Steitz Secura ERGO-SOFT	21388	Medium	4/4	35 - 48	completely glued
WBPR_	EVA ESD black	-	-	Medium	3/4	-	non glued*

\*According to DGUV 112 - 191 only in connection with cover GA01, GA02, GA03, GA04

### BASE/BOTTOM COVER

EVA ESD black, 55° Shore A, 1.5 mm

#### CHARACTERISTICS

- Antistatic
- Disinfectable and washable surface

### FOOT ORTHOTIC SHELL

Acrylic composite material made of woven glass fiber and knitted polyamide (GH702)

#### CHARACTERISTICS

- Good thermalplastic processing at 130° - 140° C
- Optimal support of the foot's longitudinal arch

### HEEL AREA WITHOUT SHELL

Thin heel portion for a natural feeling for ground contact.

### TOP COVER

Steitz Secura ERGO-SOFT ESD  
Steitz Secura Logo + PU foam black, 35° Shore A, 2.0 mm

#### CHARACTERISTICS

- Very good moisture absorption and release
- Abrasion resistant
- Odor control through activated carbon absorbers in the foam

### MET PAD

The soft, drop-shaped met pad 21388 made of Carbosan foam supports the transversal arch and relieves the forefoot area.

### REINFORCING LAYER

An additional reinforcing layer provides smooth transitions and gives the orthotic blank further stability.



# WORKER<sup>2</sup> CALCA STEITZ SECURA

After further processing by orthopedic technicians the WORKER<sup>2</sup> CALCA STEITZ SECURA orthotic blank is specially suited to counteract chronically painful heel area complaints, e.g. plantar fasciitis or heel spurs, in work safety shoes. The particularly extensive, drop-shaped recess in the self-supporting Perpedes glass fiber composite shell is orientated on the plantar fascia's anatomical location and stretches to the foot's longitudinal arch. The moderate longitudinal arch support and the double layered red PUR Slow Memory foam in

the heel area have a dampening and impact relieving effect. The orthotic shell can be optionally shaped due to its thermoplastic properties and can, therefore, be uniquely adapted to the user's foot and requirements. The STEITZ SECURA ESD material, consisting of microfiber in combination with the soft PUR foam, offers comfort in work safety shoes. A soft, drop-shaped met pad made of Carbosan foam supports the transversal arch and relieves the forefoot area.



## CHARACTERISTICS

- Supportive foot orthotic blank
- Calcaneal spur recess and cushion
- Long-soled soft cushion (optional)
- Heel lift (optional)

## PRODUCT FACTS

Size range:	35 - 48
Width:	Medium
Foot orthotic shell:	Acrylic composite material made of woven glass fiber and knitted polyamide (GH702)
Outline:	Square (Worker)
3D-Contour:	R = higher longitudinal arch support with guided heel
Special feature:	Anatomically correct recess for plantar fasciitis / heel spur

## BESTSELLERS WORKER<sup>2</sup> CALCA STEITZ SECURA

ITEM NO.	BASE COVER	TOP COVER	MET PAD	WIDTH	LENGTH	SIZE RANGE	FINISHING STATUS
WOCAKE_	EVA ESD black	Steitz Secura ERGO-SOFT	21388	Medium	4/4	35 - 48	completely glued
WBCA_	EVA ESD black		-	Medium-	3/4	-	non glued*

\*According to DGVV 112 - 191 only in connection with cover GA01, GA02, GA03, GA04

### BASE/BOTTOM COVER

EVA ESD black, 55° Shore A, 1.5 mm

#### CHARACTERISTICS

- Antistatic
- Disinfectable and washable surface

### FOOT ORTHOTIC SHELL

Acrylic composite material made of woven glass fiber and knitted polyamide (GH702)

#### CHARACTERISTICS

- Good thermalplastic processing at 130° - 140° C
- Optimal support of the foot's longitudinal arch

### HEEL RECESS

The particularly extensive, drop-shaped heel recess provides the space for a shock absorbing heel pad and distributes the body load from the central Calcaneus to the lateral, usually pain-free areas of the heel.

### TOP COVER

Steitz Secura ERGO-SOFT ESD  
Steitz Secura Logo + PU foam black, 35° Shore A, 2.0 mm

#### CHARACTERISTICS

- Very good moisture absorption and release
- Abrasion resistant
- Odor control through activated carbon absorbers in the foam

### MET PAD

The soft, drop-shaped met pad 21388 made of Carbosan foam supports the transversal arch and relieves the forefoot area.

### REINFORCING LAYER

An additional reinforcing layer provides smooth transitions and gives the orthotic blank further stability.

### HINDFOOT CUSHION

The open celled, 3mm red PUR Slow Memory foam in the heel area with its 12° Shore A is used double layered in the shell's recess. This softness has a dampening and pain relieving effect, as it absorbs impact forces.



# WORKER<sup>2</sup> CPX STEITZ SECURA

After further processing by orthopedic technicians the WORKER<sup>2</sup> CPX STEITZ SECURA orthotic blank is specially suited to counteract acutely painful complaints due to overloading in the heel area, e.g. plantar fasciitis or Calcaneal spurs, in work safety shoes. The shell's heel recess in combination with the uniquely low positioning of the plantar fascia in the self-supporting Perpedes glass fiber composite shell is orientated on the fascia's anatomical location and stretches well within the foot's longitudinal arch. The moderate arch support and the double layered PUR Shock Absorber X

combined with the incorporated PUR Slow Memory cushioning material optimally reduce impact forces. The orthotic shell can be optionally shaped due to its thermoplastic properties and can, therefore, be uniquely adapted to the user's foot and requirements. The Steitz Secura ERGO-SOFT ESD material, consisting of microfiber in combination with the soft PUR foam, offers comfort in work safety shoes. A soft, drop-shaped met pad made of Carbosan foam supports the transversal arch and relieves the forefoot area.



WORKER<sup>2</sup> CPX STEITZ SECURA  
WOCXKE\_

## CHARACTERISTICS

- Supportive foot orthotic blank
- Calcaneal spur recess and cushion
- Long-sole soft cushion (optional)
- Heel lift (optional)

## PRODUCT FACTS

Size range: 35 - 48  
 Width: Medium  
 Foot orthotic shell: Acrylic composite material made of woven glass fiber and knitted polyamide (GH702)  
 Outline: Square (Worker)  
 3D-Contour: PX = moderate longitudinal arch support with plantar fascia groove in the shell  
 Special feature: Anatomically correct recess for plantar fasciitis / heel spur with plantar fascia groove for maximum relief

## BESTSELLERS WORKER<sup>2</sup> CPX STEITZ SECURA

ITEM NO.	BASE COVER	TOP COVER	MET PAD	WIDTH	LENGTH	SIZE RANGE	FINISHING STATUS
WOCXKE_	EVA ESD black	Steitz Secura ERGO-SOFT	21388	Medium	4/4	35 - 48	completely glued
WBCX_	EVA ESD black	-	-	Medium	3/4	-	non glued*

\*According to DGUV 112 - 191 only in connection with cover GA01, GA02, GA03, GA04

### BASE/BOTTOM COVER

EVA ESD black, 55° Shore A, 1.5 mm

#### CHARACTERISTICS

- Antistatic
- Disinfectable and washable surface

### FOOT ORTHOTIC SHELL

Acrylic composite material made of woven glass fiber and knitted polyamide (GH702)

#### CHARACTERISTICS

- Good thermalplastic processing at 130° - 140° C
- Optimal support of the foot's longitudinal arch

### HEEL RECESS WITH FASCIA GROOVE

The shell's anatomically correct heel recess in combination with the low positioning of the fascia runs well within the foot's longitudinal arch. The heel recess provides the space for a shock absorbing heel pad and distributes the body load from the central Calcaneus to the lateral, usually pain-free areas of the heel.

### TOP COVER

Steitz Secura ERGO-SOFT ESD  
Steitz Secura Logo + PU foam black, 35° Shore A, 2.0 mm

#### CHARACTERISTICS

- Very good moisture absorption and release
- Abrasion resistant
- Odor control through activated carbon absorbers in the foam

### MET PAD

The soft, drop-shaped met pad 21388 made of Carbosan foam supports the transversal arch and relieves the forefoot area.

### REINFORCING LAYER

An additional reinforcing layer provides smooth transitions and gives the orthotic blank further stability.

### HINDFOOT CUSHION

The open celled, 3mm yellow Shock Absorber X PUR foam in the heel area with its 7° Shore A is double layered in the shell's recess. This softness has a dampening and pain relieving effect, as it effectively absorbs impact forces.







# INJECTION MOULDING

Injection molded orthotic blanks are best for a price-sensitive clientele. The PP250 and PES252 offer an uncomplicated entry to foot treatment with insoles. Due to its thermoplastic properties, the injection-molded shell, which is available in two widths, is able to adapt to the foot simply and quickly.

PP250  
Page 116

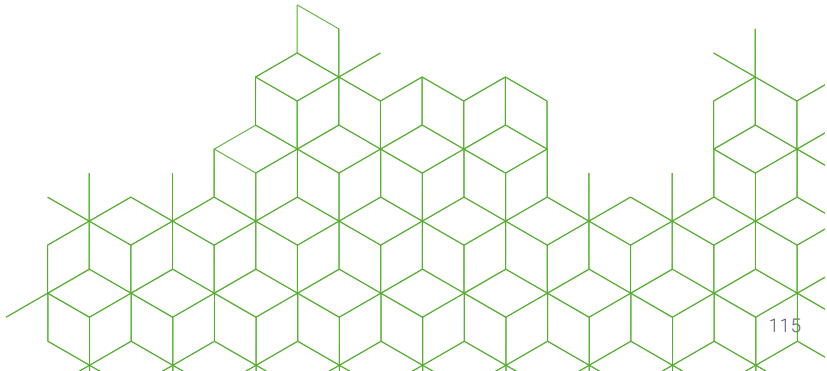

# PP250

The PP250 orthotic blank is specially designed for users who prefer an insole shell with a full heel. The self-supporting polypropylene injection moulded shell supports the foot's longitudinal arch. The shell, which is available in two widths, can be optionally

shaped due to its thermoplastic properties and can, therefore, be uniquely adapted to the user's foot. Optionally, the PP250 can be supplemented by soft Carbosan foam met pads which support the transversal arch.



## CHARACTERISTICS

- Supportive foot orthotic blank

## PRODUCT FACTS

Size range:	35 - 48
Width:	Narrow (35 - 42) / Medium (35 - 48)
Foot orthotic shell:	Polypropylene
Outline:	Vario
3D-Contour:	N = moderate longitudinal arch support with slightly guided heel H = slight heel pitch with flat heel
Special feature:	Shell includes heel area

## BESTSELLERS PP250

ITEM NO. <b>OLD</b>	ITEM NO. <b>NEW</b>	BASE COVER	WIDTH	3D-CONTOUR	LENGTH	SIZE RANGE
2NC_	SGNC_	Vildona Fleece cognac (U)	Narrow	N	3/4	35 - 42
2NA_	SGNA_	Vildona Fleece cognac (U)	Medium	N	3/4	35 - 48
2NB_	SGNB_	Vildona Fleece cognac (U)	Medium	N	4/4	35 - 48

## BASE/BOTTOM COVER

Vildona Fleece, cognac (U)

MATERIAL COMPOSITION  
PES + PA \* PP

### CHARACTERISTICS

- High abrasion resistance
- Breathable
- Colorfast and lightfast
- With hot-melt coating



## FOOT ORTHOTIC SHELL

Polypropylene

# PES252

The PES252 orthotic blank is specially designed for users who prefer an insole with a full heel. The self-supporting injection moulded shell made from glass fiber reinforced synthetic material supports the foot's longitudinal arch. The shell, which is avail-

able in two widths, can be optionally shaped due to its thermo-plastic properties and can, therefore, be uniquely adapted to the user's foot. Optionally, the PES252 can be supplemented by soft Carbosan foam met pads which support the transversal arch.



PES252  
SGKM\_

## CHARACTERISTICS

- Supportive foot orthotic blank

## PRODUCT FACTS

Size range:	35 - 46
Width:	Narrow (35 - 44) / Medium (35 - 46)
Foot orthotic shell:	Fiberglass reinforced plastic
Outline:	Vario
3D-Contour:	N = moderate longitudinal arch support with slightly guided heel K = slight heel pitch with flat heel
Special feature:	Shell includes heel area

## BESTSELLERS PES252

ITEM NO. <b>OLD</b>	ITEM NO. <b>NEW</b>	BASE COVER	WIDTH	3D-CONTOUR	LENGTH	SIZE RANGE
252KS_	SGKS_	Vildona Fleece cognac (P)	Narrow	N	3/4	35 - 42
252KM_	SGKM_	Vildona Fleece cognac (P)	Medium	N	3/4	35 - 46

## BASE/BOTTOM COVER

Vildona Fleece, cognac (P)

MATERIAL COMPOSITION  
50% PUR + 50% PA

### CHARACTERISTICS

- High abrasion resistance
- Slightly slip-resistant
- Colorfast and lightfast



## FOOT ORTHOTIC SHELL

Fiberglass reinforced plastic



# ACCOMMODATIVE FOOT ORTHOSES



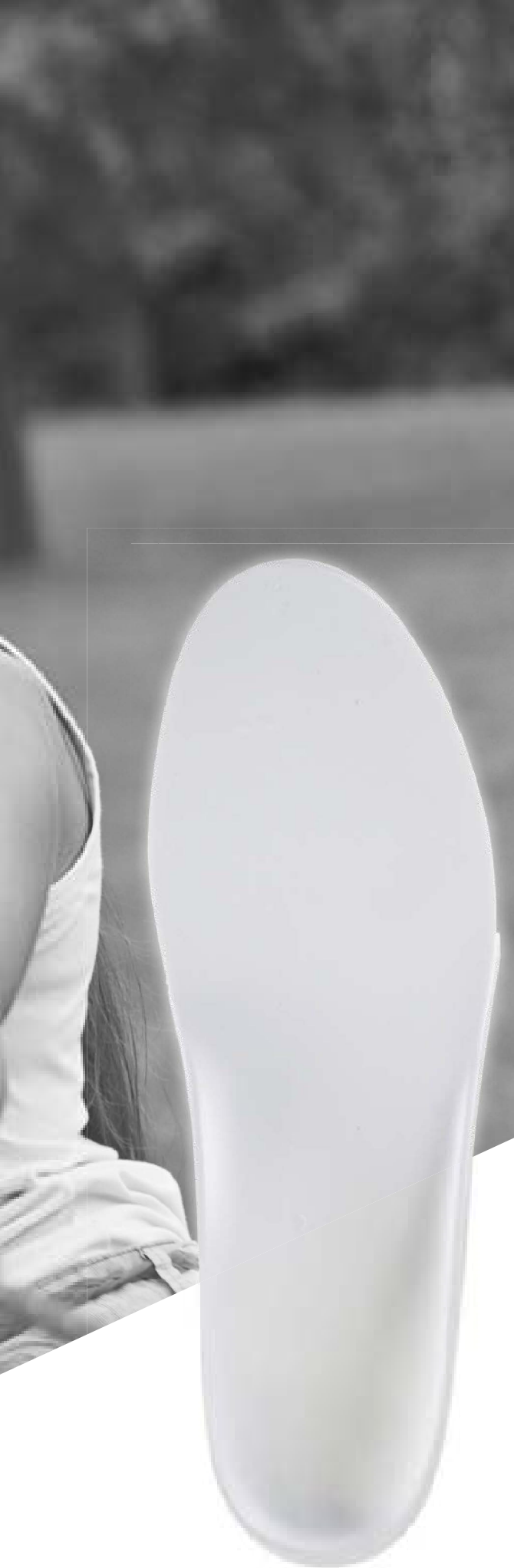

## SOFT

The SOFT line stands for comfortable, accommodative foot orthotic treatment in insole-friendly footwear. Best suited to people who are on their feet a lot and whose feet and clinical symptoms particularly require an accommodative bedding. SOFT, SOFT SPEEDY, SOFT SPORT and SOFT CALCA optimally distribute the body weight and harmonize plantar pressure peaks. The SOFT line is based on a soft yet dimensionally stable EVA material which, due to its thermoplastic properties, is able to adapt to the foot simply and uniquely. Insoles from the SOFT line require final processing on a grinder in order to have their thickness and arch support adapted to the foot and the specific shoe requirements. High-quality materials which meet Perpedes' high quality demands are used in the SOFT line.

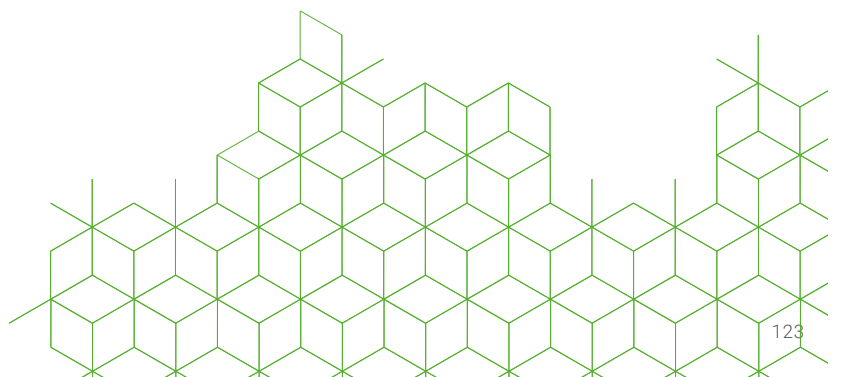

# SOFT

After further processing by orthopedic technicians the SOFT orthotic blank is best suited for effectively relieving pressure on the foot. Due to the dimensionally stable yet comfortable, soft 30° Shore A EVA foam, available in different outlines, e.g. short, 3/4, long-soled (comfort shoe or vario shape), overloading is counteracted and pressure points are being reduced. The pre-formed,

moderate longitudinal arch supports the foot ideally. Optionally, the SOFT can be fitted out with a mild or medium reinforcement layer, with a preformed met pad or an additional longitudinal arch filling. We recommend top covers for even more functionalities and wearing comfort.



SOFT  
BSCJ\_

## CHARACTERISTICS

- Accommodative orthotic, weight and pressure distributing

## PRODUCT FACTS

Size range:	35 - 48
Width:	Narrow / Medium
Foot orthotic base:	EVA 30° Shore A, white EVA 30° Shore A, black
Outline:	Comfort Vario
3D-Contour:	N = moderate longitudinal arch support with slightly guided heel
Special feature:	With and without reinforcement available

## BESTSELLERS SOFT

ITEM NO. OLD	ITEM NO. NEW	SHELL/BASE	REINFORCING LAYER	WIDTH	OUTLINE	LENGTH	SIZE RANGE
SC80V_	BSAW_	EVA 30° Shore A, black	-	Medium	Vario	4/4	35 - 48
SCV_	BSCJ_	EVA 30° Shore A, white	-	Medium	Vario	4/4	35 - 48

## FOOT ORTHOTIC BASE

EVA 30° Shore A, white

MATERIAL COMPOSITION  
90% EVA + 10% SBR

### CHARACTERISTICS

- Closed cell structure
- Soft
- High resilience
- Disinfectable and surface washable
- Good cushioning characteristics
- Very good tear resistance

Tolerance approx.  
+/- 5° Shore A



## OUTLINE

Comfort / Vario



## CUPPED HEEL

For optimized rear foot guidance the heel is cupped.

# SOFT SPEEDY

After further processing by orthopedic technicians the SOFT SPEEDY is therefore best suited for effectively relieving pressure on the foot. Due to the dimensionally stable yet comfortable, soft 30° or firm 50° Shore A EVA foam, available in different outlines, e.g. short, 3/4, long-soled (comfort shoe or vario shape), overloading is counteracted and pressure points are being reduced. The

preformed, moderate longitudinal arch supports the foot ideally. Optionally, the SOFT SPEEDY can be fitted out with a mild or medium reinforcement layer and/or an additional longitudinal arch filling. We recommend top covers for even more functionalities and wearing comfort.



SOFT SPEEDY  
BYBNL

## CHARACTERISTICS

- Accommodative orthotic, weight and pressure distributing

## PRODUCT FACTS

Size range:	35 - 48
Width:	Narrow / Medium
Foot orthotic base:	EVA 30° Shore A, white EVA 30° Shore A, black EVA 50° Shore A, white
Outline:	Comfort Vario
3D-Contour:	N = moderate longitudinal arch support with slightly guided heel
Special feature:	With and without reinforcement available

## BESTSELLERS SOFT SPEEDY

ITEM NO. OLD	ITEM NO. NEW	SHELL/BASE	REINFORCING LAYER	WIDTH	OUTLINE	LENGTH	SIZE RANGE
SY180V_	BYBNL	EVA 30° Shore A, black	-	Medium	Vario	4/4	35 - 48
SY1V_	BYBL_	EVA 30° Shore A, white	-	Medium	Vario	4/4	35 - 48
SY2V_	BYBR_	EVA 50° Shore A, white	-	Medium	Vario	4/4	35 - 48

## FOOT ORTHOTIC BASE

EVA 30° Shore A, black

### MATERIAL COMPOSITION

90% EVA + 10% SBR

### CHARACTERISTICS

- Closed cell structure
- Soft
- High resilience
- Disinfectable and surface washable
- Good cushioning characteristics
- Very good tear resistance

Tolerance approx.  
+/- 5° Shore A



## OUTLINE

Comfort / Vario



## CUPPED HEEL

For optimized rear foot guidance the heel is cupped.

# SOFT SPORT

After further processing by orthopedic technicians the SOFT SPORT orthotic blank is best suited for effectively relieving pressure on the foot. Due to the dimensionally stable yet comfortable, medium soft 40°/45° Shore A EVA foam, overloading during sporting activities is counteracted and pressure points are distributed.

The pre-shaped longitudinal arch in combination with a mild reinforcement supports the foot moderately and in an ideal way for sporting requirement. We recommend top covers for even more functionalities and wearing comfort.



SOFT SPORT  
BTCD\_

## CHARACTERISTICS

- Accommodative orthotic, weight and pressure distributing

## PRODUCT FACTS

Size range:	35 - 48
Width:	Narrow / Medium
Foot orthotic base:	EVA 40° Shore A, white
Outline:	Comfort, Vario
3D-Contour:	N = moderate longitudinal arch support with slightly guided heel
Special feature:	With and without reinforcement available

## BESTSELLERS SOFT SPORT

ITEM NO. OLD	ITEM NO. NEW	SHELL/BASE	REINFORCING LAYER	WIDTH	OUTLINE	LENGTH	SIZE RANGE
SSPV_	BTCD_	EVA 40°/45° Shore A, white	-	Medium	Vario	4/4	35 - 48

## FOOT ORTHOTIC BASE

EVA 40° Shore A, white

### MATERIAL COMPOSITION

100% EVA

### CHARACTERISTICS

- Closed cell structure
- Soft
- High resilience
- Disinfectable and surface washable
- Good cushioning characteristics
- Very good tear resistance

Tolerance approx.

+/- 5° Shore A



## OUTLINE

Comfort / Vario



## CUPPED HEEL

For optimized rear foot guidance the heel is cupped.

# SOFT CALCA

After further processing by orthopedic technicians the SOFT CALCA orthotic blank is specially designed for use with chronically painful heel area complaints, e.g. for plantar fasciitis or heel spurs. Due to the dimensionally stable yet comfortable, soft 30° Shore A EVA foam, overloading is counteracted and the pressure under the heel area can be significantly reduced. The drop-shaped recess in the SOFT CALCA's base is orientated on the plantar

fascia's anatomical location and is cushioned with PUR Slow Memory foam. Along with the moderate arch support, this produces perceptible dampening and pain reduction. Optionally, the SOFT CALCA can be fitted out with a mild or medium reinforcement layer, with a preformed met pad or an additional longitudinal arch filling. We recommend top covers for even more functionalities and wearing comfort.



## CHARACTERISTICS

- Accommodative orthotic, weight and pressure distributing

## PRODUCT FACTS

Size range: 35 - 48  
 Width: Narrow / Medium  
 Foot orthotic base: EVA 30° Shore A, black  
 EVA 30° Shore A, white  
 Outline: Comfort / Finn  
 3D-Contour: N = moderate longitudinal arch support with slightly guided heel  
 Special feature: Heel cushion pad made from 12° Shore A Slow-Memory foam (non glued)  
 With and without reinforcement available

## BESTSELLERS SOFT CALCA

ITEM NO. OLD	ITEM NO. NEW	SHELL/BASE	REINFORCING LAYER	WIDTH	OUTLINE	LENGTH	SIZE RANGE
CS9_	BAS9_	EVA 30° Shore A, black	mild reinforcing layer	Medium	Finn	4/4	35 - 48
CS8_	BAS8_	EVA 30° Shore A, white	mild reinforcing layer	Medium	Comfort	4/4	35 - 48

## FOOT ORTHOTIC BASE

EVA 30° Shore A, black

### MATERIAL COMPOSITION

90% EVA + 10% SBR

### CHARACTERISTICS

- Closed cell structure
- Soft
- High resilience
- Disinfectable and surface washable
- Good cushioning characteristics
- Very good tear resistance

Tolerance approx.  
+/- 5° Shore A



## OUTLINE

3/4, Comfort / Finn

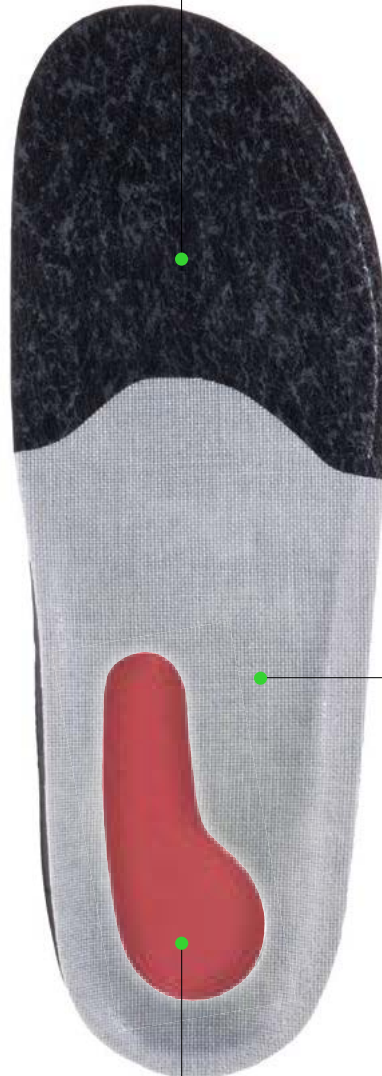

## REINFORCING LAYER

Optional with and without available

## HEEL SPUR CUSHION PAD

Incorporated heel cushion pad made of red 12° Shore A Slow-Memory foam (non glued) to optimally reduce impact forces.



# HEEL CUPPED FOOT ORTHOSES





## FREEE!!!

The FREEE!!! line stands for stable rear foot guidance combined with all-over cushioning and redistribution of pressure in insole-friendly footwear. FREEE!!! SOFT, FREEE!!! COMFORT and FREEE!!! SPORT are treatment options with a limited amount of finishing investment. The FREEE!!! line is based on a pre-formed, dimensionally stable insole base with heel cup made from rubbery cork which, due to its thermoplastic properties, is able to adapt to the foot uniquely. Due to its base geometry, the FREEE!!! insole range offers the MTP joint 1 enough space for natural movement. High-quality materials which meet Perpedes' high quality demands are used in the FREEE!!! line.

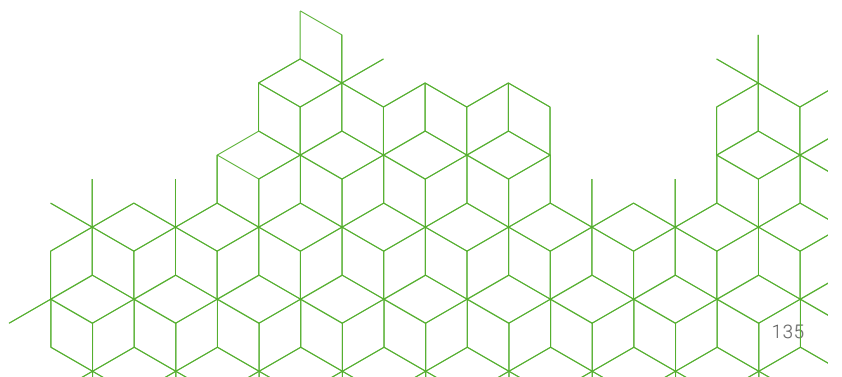

# FREEE!!! SOFT

The FREEE!!! SOFT orthotic blank is designed for feet which are sensitive to pressure. The pre-formed and dimensionally stable insole base with heel cup made from rubbery cork moderately supports the longitudinal arch and gently guides the rear foot. Due to its thermoplastic properties, the rubber cork base is able

to adapt to the foot uniquely. The FREEE!!! SOFT is completed by a non-glued but pre-formed EVA cover (25° Shore A) which cushions the foot and distributes the body weight evenly. Optionally, the FREEE!!! SOFT can be supplemented by soft, drop-shaped Carbosan foam met pads which support the transversal arch.



FREEE!!! SOFT  
FRSFLA\_

## CHARACTERISTICS

- Heel cupped blank, solid, (thermal) remoldable
- Long-soled soft cushion

## PRODUCT FACTS

Size range: 1 - 13 (33 - 47)  
 Width: Narrow (3 - 13) / Medium (1 - 13)  
 Foot orthotic base: Rubber Cork-EVA  
 Outline: Vario  
 3D-Contour: N = moderate longitudinal arch support with slightly guided heel  
 Special feature: Cupped hindfoot

## BESTSELLERS FREEE!!! SOFT

ITEM NO. OLD	ITEM NO. NEW	SHELL/BASE	TOP COVER	MET PAD	WIDTH	LENGTH	SIZE RANGE	FINISHING STATUS
FSF_	FRSFLA_	Rubber Cork-EVA	EVA 20° Shore A, white	2031	Medium	4/4	1 - 13	non-glued

## FOOT ORTHOTIC BASE

Rubber Cork EVA

## CUPPED HEEL

For optimized rear foot guidance the heel is cupped.

## PRE-SHAPED TOP COVER

EVA 20° Shore A,  
weiß, 6 mm

MATERIAL  
COMPOSITION  
50% EVA / 10% SBR

### CHARACTERISTICS

- Closed cell structure
- Soft
- High resilience
- Disinfectable and surface washable
- Good cushioning characteristics
- Very good tear resistance

Tolerance approx.  
+/- 5° Shore A



# FREEE!!! COMFORT

The FREEE!!! COMFORT orthotic blank is designed for feet which are in need of comfort. The pre-formed and dimensionally stable insole base with heel cup made from rubbery cork moderately supports the longitudinal arch and gently guides the rear foot. Due to its thermoplastic properties, the rubber cork base is able to adapt to the foot uniquely. The FREEE!!! COMFORT is complet-

ed by a non-glued but pre-formed EVA cover (30° Shore A) which cushions the foot and distributes the body weight evenly. Optionally, the FREEE!!! COMFORT can be supplemented by soft, drop-shaped Carbosan foam met pads which support the transversal arch.



FREEE!!! COMFORT  
FRCALA

## CHARACTERISTICS

- Heel cupped blank, solid, (thermal) remoldable
- Long-soled soft cushion

## PRODUCT FACTS

- Size range: 1 - 13 (33 - 47)  
 Width: Narrow (3 - 13) / Medium (1 - 13)  
 Foot orthotic base: Rubber Cork-EVA  
 Outline: Vario  
 3D-Contour: N = moderate longitudinal arch support with slightly guided heel  
 Special feature: Cupped hindfoot

## BESTSELLERS FREEE!!! COMFORT

ITEM NO. OLD	ITEM NO. NEW	SHELL/BASE	TOP COVER	MET PAD	WIDTH	LENGTH	SIZE RANGE	FINISHINGSTATUS
FC_	FRCALA_	Rubber Cork-EVA	EVA 25° Shore A, beige	2031	Medium	4/4	1 - 13	non-glued

### FOOT ORTHOTIC BASE

Rubber Cork EVA

### PRE-SHAPED TOP COVER

EVA 25° Shore A, beige, 4 mm

MATERIAL COMPOSITION  
50% EVA / 10% SBR

#### CHARACTERISTICS

- Closed cell structure
- Soft
- High resilience
- Disinfectable and surface washable
- Good cushioning characteristics
- Very good tear resistance

Tolerance approx.  
+/- 5° Shore A

### CUPPED HEEL

For optimized rear foot guidance the heel is cupped.



# FREEE!!! SPORT

After further processing by orthopedic technicians the FREEE!!! SPORT orthotic blank is ideally suited to prevent injury during sporting activities. The pre-formed and dimensionally stable insole base with heel cup made from rubbery cork moderately supports the longitudinal arch and gently guides the rear foot. Due to its thermoplastic properties, the rubber cork base is able to

adapt to the foot uniquely. The FREEE!!! SPORT is completed by a non-glued but pre-formed EVA cover (40° Shore A) which cushions the foot and distributes the body weight evenly. Optionally, the FREEE!!! SPORT can be supplemented by soft, drop-shaped Carbosan foam met pads which support the transversal arch.



FREEE!!! SPORT  
FRPALA\_

## CHARACTERISTICS

- Heel cupped blank, solid, (thermal) remoldable
- Long-sole soft cushion

## PRODUCT FACTS

- Size range: 1 - 13 (33 - 47)
- Width: Narrow (3 - 13) / Medium (1 - 13)
- Foot orthotic base: Rubber Cork-EVA
- Outline: Vario
- 3D-Contour: N = moderate longitudinal arch support with slightly guided heel
- Special feature: Cupped hindfoot

## BESTSELLERS FREEE!!! SPORT

ITEM NO. OLD	ITEM NO. NEW	SHELL/BASE	TOP COVER	MET PAD	WIDTH	LENGTH	SIZE RANGE	FINISHING STATUS
FSP_	FRPALA_	Rubber Cork-EVA	EVA 35° Shore A, blue	2031	Medium	4/4	1 - 13	non-glued

### FOOT ORTHOTIC BASE

Rubber Cork EVA



### CUPPED HEEL

For optimized rear foot guidance the heel is cupped.

### PRE-SHAPED TOP COVER

EVA 35° Shore A, dark blue, 4 mm

MATERIAL COMPOSITION  
50% EVA / 10% SBR

#### CHARACTERISTICS

- Closed cell structure
- Soft
- High resilience
- Disinfectable and surface washable
- Good cushioning characteristics
- Very good tear resistance

Tolerance approx.  
+/- 5° Shore A

### CUSHION LAYER / TOP COVER

Pre-spaped





# SENSOMOTORIC FOOT ORTHOSES





## TONUSCONTROL

TONUSCONTROL is a modular insole concept which sustainably improves proprioceptive perception, motor coordination and therefore avoids incorrect loading. By stimulating targeted sensors in the foot muscles and joints, changed positioning information are sent to the brain. The brain sends regulating impulses back to the muscles in order to achieve the desired aligning effect. Soft, dimensionally stable pads which are placed on a slightly cupped orthotic base are used to stimulate the relevant areas of the plantar foot. With every step motor coordination is improved and incorrect loading can be avoided.

TONUSCONTROL

Page 148

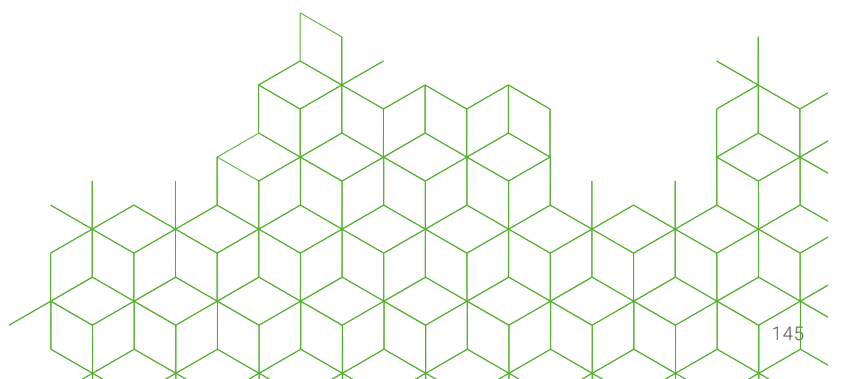

# TONUSCONTROL

## THE MODULAR, SENSOMOTORIC FOOT ORTHOTIC SYSTEM

### TONUSCONTROL

TonusControl uses soft pads at various zones as ‚pulse emitters‘ that are easily placed on a slightly cupped orthotic shell. Pad’s shape, size, position and therefore the level of stimuli can be adapted to the course of treatment.

### INDICATIONS

- All non-rigid foot deformities
- Pain symptoms due to malaligned foot and body posture
- Muscle tension
- Back and neck pain
- Sport-related complaints (knee joint complaints / ligament strain)

### CONTRAINDICATIONS

- Contractures
- Muscular dystrophies
- Neuropathies
- Artery occlusive diseases

### TREATMENT RESULTS

- Significant harmonization of muscle imbalances
- Increased mobility
- Pain relief

### BENEFITS

- Size and position of the pads can always be adapted to the course of therapy
- Repeal of muscular imbalances of the foot
- Positive effect on the overall locomotor and skeletal system
- Low inventory due to modular nature of TonusControl treatment concept



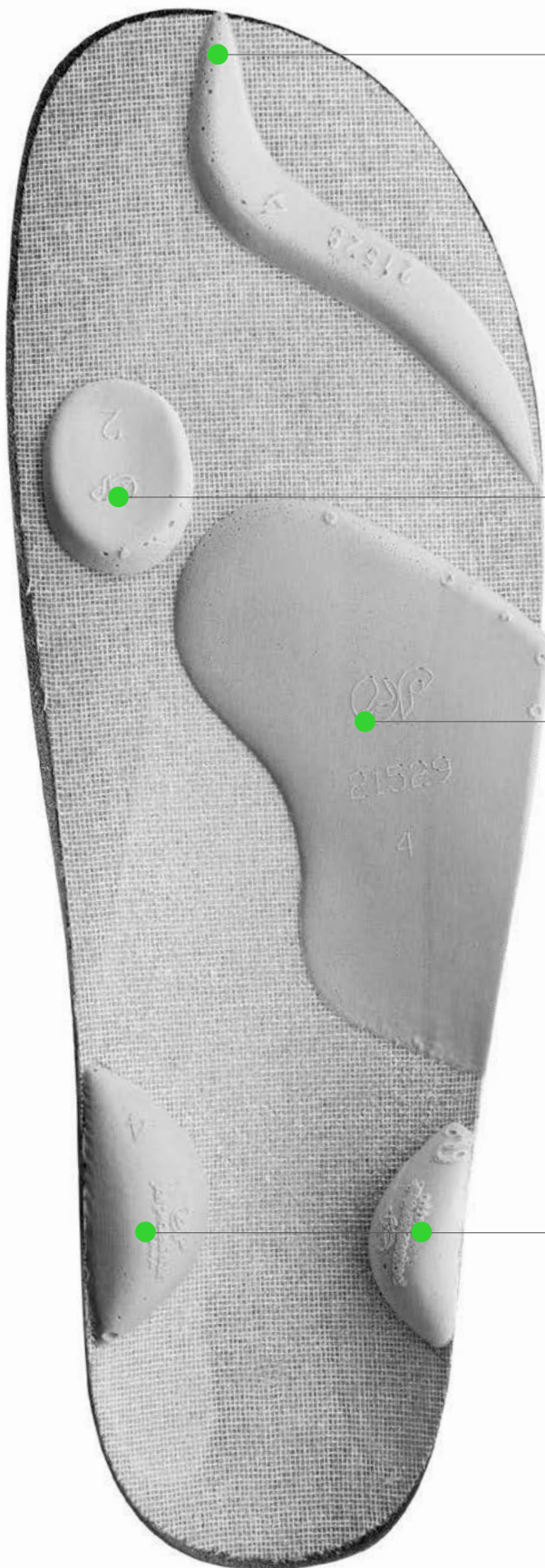

### TOE REST (PASSIVE)

The TonusControl toe rest elevates the longitudinal foot arch, suitable for Pes valgus.

### TOE CREST (ACTIVE)

Improves the sense of position and spatial coordination. Regulates the tonus of the deep calf muscles. This tonus alignment affects the entire locomotor and musculo-skeletal system, suitable for Pes cavus deformities.

### MTP 1-PAD (PASSIVE)

Reduces muscle tonus in the longitudinal arch and in the plantarflexing toe muscles during the propulsion phase.

### SENSOMOTORIC MET PAD (ACTIVE)

Through impulses to the body's regulatory mechanisms, the TonusControl active met pad triggers the reduced muscle tension in the posterior calf muscles, the foot position aligned. Via the muscle chain the back and shoulder muscles are affected positively.

### SENSOMOTORIC MET PAD (PASSIVE)

The TonusControl passive met pad stabilizes the sensory structures of the subtalar joint. To be used for more pronounced and / or progressive valgus deformities.

### HINDFOOT PADS

Hindfoot pads control the hindfoot and ankle alignment on the tibial and lateral calf muscles. By stimulating the so-called „muscular stirrup“ the muscle latency and the risk of injury is reduced around the ankle. Via the foot's reflexology zones the pelvis muscles can be addressed.

# TONUSCONTROL

After further processing by orthopedic technicians the TONUSCONTROL shell is specially designed for use with the TONUSCONTROL sensomotor insole concepts. The self-supporting Perpedes glass fiber composite shell with its full heel optimally supports the foot's longitudinal arch and guides the heel when walking. The stable edge offers counter support so that the sensomotoric pads can be

individually placed. An additional long-sole reinforcing layer gives the orthotic blank dimensional stability. The TONUSCONTROL support shell set includes the interim top cover Pronoppy in grey and optionally the final top cover DryFeet dark blue with Tonus-Control print.



## CHARACTERISTICS

- Supportive foot orthotic blank

## PRODUCT FACTS

Size range:	17 - 48
Width:	Medium
Foot orthotic shell:	Acrylic composite material made of knitted glass fiber (G421)
Outline:	Comfort
3D-Contour:	TC = low longitudinal arch support with slightly guided heel
Special feature:	Shell includes heel area

## BESTSELLERS TONUSCONTROL

ITEM NO. OLD	ITEM NO. NEW	BASE COVER	ADDITION	WIDTH	LENGTH	SIZE RANGE
TCCG_	TCCG_	EVA green	-	Medium	4/4	17 - 48
TCE_	TCCE_	TPU black	-	Medium	4/4	17 - 48
TCT_	TCCTLA_	TPU black	Interim top cover Pronoppy grey	Medium	4/4	17 - 48

## BASE/BOTTOM COVER

EVA 50° Shore A, green, 1.5 mm

### CHARACTERISTICS

- Closed cell structure
- Soft
- High resilience
- Disinfectable and surface washable
- Good cushioning characteristics
- Very good tear resistance

Tolerance approx.

+/- 5° Shore A

## FOOT ORTHOTIC SHELL

Acrylic composite material made of knitted glass fiber (G421)

### CHARACTERISTICS

- Very good thermalplastic processing at approx. 140° C
- Optimal support of the foot's longitudinal arch

## LONG REAR WINGS

Stabilized heel by long rear wings.

## REINFORCING LAYER

An additional reinforcing layer provides smooth transitions and gives the orthotic blank further stability.

## SHELL RECESS

Ensures a thin heel that fits in many types of footwear.



## TONUSCONTROL STARTER SET

ITEM NO.	DESCRIPTION	CONTENT
TCS	TONUSCONTROL STARTER SET UNIVERSAL	Carry case containing 180 pcs. of TonusControl pads, 12 pairs of TonusControl support shells „Classic“ (choice of size), sample top cover Pronoppy, final top cover DryFeet dark blue with black Tonuscontrol print, base cover TPU

## TONUSCONTROL CARRY CASE

ITEM NO.	DESCRIPTION	CONTENT
TCP	TONUSCONTROL CARRY CASE UNIVERSAL	Perpedes carry case with 180 pcs of pads (without shell)

## TONUSCONTROL SUPPORT SHELLS

ITEM NO. <b>OLD</b>	ITEM NO. <b>NEW</b>	DESCRIPTION	BASE COVER	INTERIM TOP COVER	FINAL TOP COVER	3D-CONTOUR
TCT_D24	TCCTLC_	TONUSCONTROL shell "Classic"	TPU black	Pronoppy grey	DryFeet blue / black TC print	TC
TCT_D22	-	TONUSCONTROL shell "Classic"	TPU black	Pronoppy grey	Coolmax Lycra black	TC

## TONUSCONTROL ACCESSORIES

ITEM NO.	DESCRIPTION	SELLING UNIT
TCPOF	TONUSCONTROL CARRY CASE	-
79KS	TONUSCONTROL ADHESIVE STRIPS	roll of 1.000 strips (25x10 mm)
SH30	PODOPAPER for taking footprints	100 sheets

ITEM NO.	DESCRIPTION	COLOR	THICKNESS	DELIVERY FORM
81PN	Interim top cover material PRONOPPY	grey	1.0 mm	Width: 137 cm (Roll 50 rtm)



# SENSOMOTORIC PADS

## TOE CREST

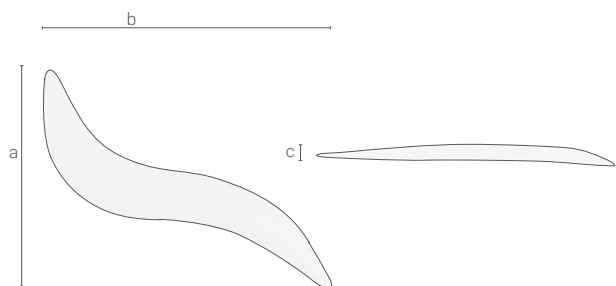

21528 made of Carbosan foam

ITEM NO.	SIZE RANGE	LENGTH (a)	WIDTH (b)	HEIGHT (c)
P215283	3	52 mm	12 mm	4 mm
P215284	4	70 mm	13 mm	4 mm
P215285	5	84 mm	18 mm	5 mm

## TOE REST

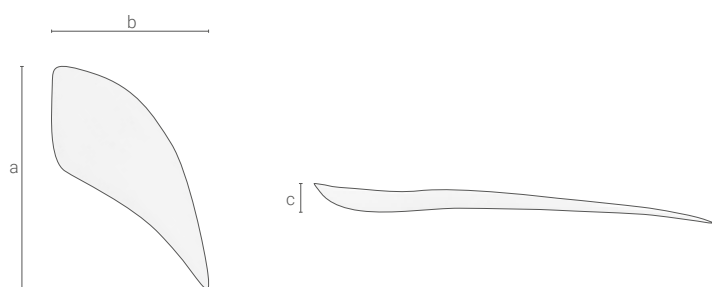

30669 made of Carbosan foam

ITEM NO.	SIZE RANGE	LENGTH (a)	WIDTH (b)	HEIGHT (c)
P306694	4	87 mm	61 mm	6 mm
P306695	5	93 mm	62 mm	7 mm
P306696	6	115 mm	65 mm	9 mm

## MPT 1 PAD

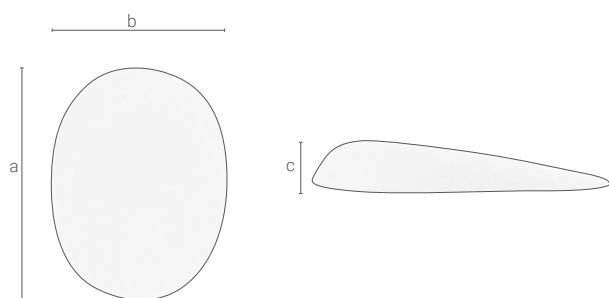

21531 made of Carbosan foam

ITEM NO.	SIZE RANGE	LENGTH (a)	WIDTH (b)	HEIGHT (c)
P2153100	00	23 mm	19 mm	4 mm
P215310	0	25 mm	20 mm	4 mm
P215311	1	29 mm	22 mm	5 mm
P215312	2	33 mm	25 mm	5 mm
P215313	3	40 mm	30 mm	7 mm

**METATARSAL PAD, ACTIVE**

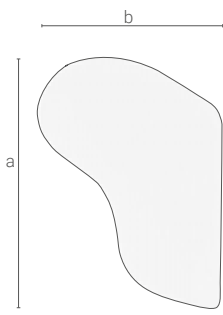

ITEM NO.	SIZE RANGE	LENGTH (a)	WIDTH (b)	HEIGHT (c)
P215291	1	62 mm	49 mm	4 mm
P215292	2	75 mm	55 mm	6 mm
P215293	3	80 mm	61 mm	7 mm
P215294	4	94 mm	67 mm	7 mm
P215295	5	105 mm	72 mm	7 mm

**21529** made of Carbosan foam

**METATARSAL PAD, PASSIVE**

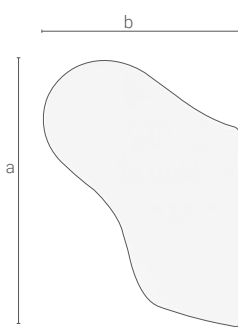

ITEM NO.	SIZE RANGE	LENGTH (a)	WIDTH (b)	HEIGHT (c)
P306683	3	84 mm	62 mm	6 mm
P306684	4	95 mm	65 mm	6 mm
P306685	5	106 mm	72 mm	7 mm

**30668** made of Carbosan foam

**HINDFOOT PAD**

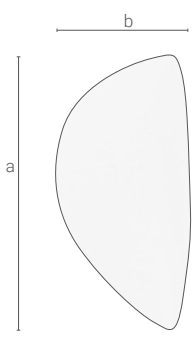

ITEM NO.	SIZE RANGE	LENGTH (a)	WIDTH (b)	HEIGHT (c)
P215301	1	35 mm	15 mm	7 mm
P215302	2	37 mm	17 mm	8 mm
P215303	3	43 mm	21 mm	9 mm
P215304	4	48 mm	24 mm	9 mm
P215305	5	53 mm	27 mm	10 mm
P215306	6	60 mm	27 mm	11 mm
P215307	7	72 mm	38 mm	12 mm

**21530** made of Carbosan foam



# SELF-SUPPORTING ORTHOTIC SHELLS





## ACRYLIC

The ACRYLIC line summarizes self-supporting orthotic shells, which are available in different arch support heights and standardized outlines. They are ideally suited for producing manually manufactured foot orthoses. For the ACRYLIC shells the wide range of Perpedes fiber composite materials with all their benefits is available. Our composite fibers are PMMA (polymethyl methacrylate) made from acrylic resin with embedded carbon or glass fiber woven or knitted fabric, often in combination with polyamide.

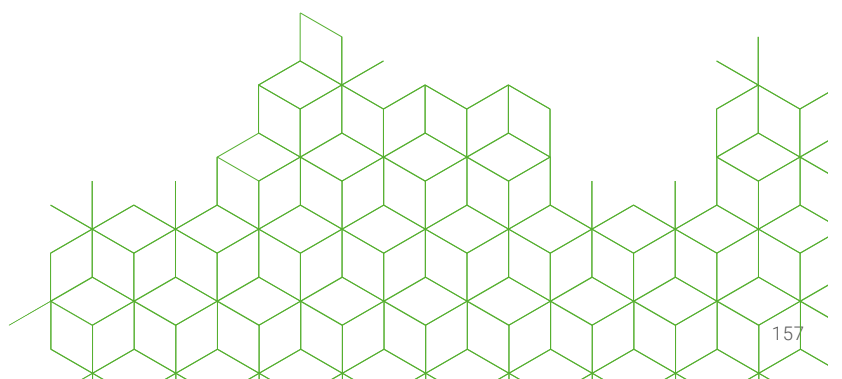

# ACRYL 101

## CHARACTERISTICS

- Supportive foot orthotic blank



Compatible with the  
**BALANCER - HEEL POST MODUL**



ACRYLIC 101  
MATERIAL: G431

## PRODUCT FACTS

Size range: 24 - 50

Width: Medium

3D-Contour: F = flat

N = moderate longitudinal arch support with slightly guided heel

NP = moderate longitudinal arch support with slightly guided heel and met pad

R = higher longitudinal arch support with guided heel

RP = higher longitudinal arch support with guided heel and met pad

Z = longitudinal arch support for higher heel springs with flat heel

Shell material: Freely selectable

(see overview acrylic fiber composite sheets)

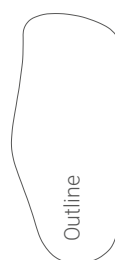

# ACRYL 101 DET

## CHARACTERISTICS

- Supportive foot orthotic blank



Compatible with the  
**BALANCER - HEEL POST MOD**



ACRYLIC 101DET  
MATERIAL: G422

## PRODUCT FACTS

Size range: 24 - 50

Width: Medium

3D-Contour: F = flat

N = moderate longitudinal arch support with slightly guided heel

NP = moderate longitudinal arch support with slightly guided heel and met pad

R = higher longitudinal arch support with guided heel

RP = higher longitudinal arch support with guided heel and met pad

Z = longitudinal arch support for higher heel springs with flat heel

Special feature: Forefoot detorsion cut

Shell material: Freely selectable

(see overview acrylic fiber composite sheets)



# ACRYL 103

## CHARACTERISTICS

- Supportive foot orthotic blank

## PRODUCT FACTS

Size range: 28 - 50

Width: Medium

3D-Contour: F = flat

N = moderate longitudinal arch support with slightly guided heel

NP = moderate longitudinal arch support with slightly guided heel and met pad

R = higher longitudinal arch support with guided heel

RP = higher longitudinal arch support with guided heel and met pad

Z = longitudinal arch support for higher heel springs with flat heel

Shell material: Freely selectable

(see overview acrylic fiber composite sheets)



ACRYLIC 103  
MATERIAL: GH702

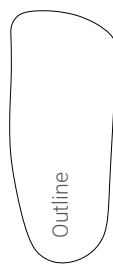

# ACRYL 116

## CHARACTERISTICS

- Supportive foot orthotic blank



Compatible with the  
**BALANCER - HEEL POST MODUL**

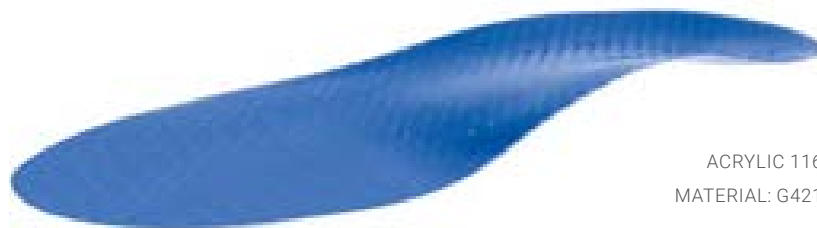

ACRYLIC 116  
MATERIAL: G421

## PRODUCT FACTS

Size range: 35 - 48

Width: Medium

3D-Contour: F = flat

N = moderate longitudinal arch support with slightly guided heel

Z = longitudinal arch support for higher heel springs with flat heel

Shell material: Freely selectable

(see overview acrylic fiber composite sheets)

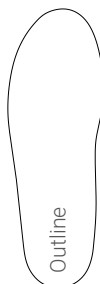

# ACRYL 113

## CHARACTERISTICS

- Supportive foot orthotic blank
- Rigidus splint



Compatible with the  
**BALANCER - HEEL POST MODUL**



ACRYLIC 113  
MATERIAL: BF7002

## PRODUCT FACTS

- Size range: 35 - 46  
Width: Medium  
3D-Contour: F = flat  
N = moderate longitudinal arch support with slightly guided heel  
Z = longitudinal arch support for higher heel springs with flat heel
- Shell material: Freely selectable  
(see overview acrylic fiber composite sheets)



# ACRYL 115

## CHARACTERISTICS

- Supportive foot orthotic blank
- Rigidus splint



Compatible with the  
**BALANCER - HEEL POST MODUL**



ACRYLIC 115  
MATERIAL: BF7001

## PRODUCT FACTS

- Size range: 35 - 48  
Width: Medium  
3D-Contour: F = flat  
N = moderate longitudinal arch support with slightly guided heel  
Z = longitudinal arch support for higher heel springs with flat heel
- Shell material: Freely selectable  
(see overview acrylic fiber composite sheets)



# ACRYL 112

## CHARACTERISTICS

- Corrective foot orthotic blank with flanges on both sides of the heel and Hallux varus splint

## PRODUCT FACTS

- Size range: 20 - 48  
Width: Medium  
3D-Contour: F = flat  
C = moderate longitudinal arch support with flat heel  
Shell material: Freely selectable  
(see overview acrylic fiber composite sheets)



ACRYLIC 112  
MATERIAL: HGH531

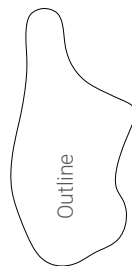

# ACRYL 114

## CHARACTERISTICS

- Corrective foot orthotic blank with flanges on both sides of the heel and Hallux varus splint

## PRODUCT FACTS

- Size range: 19/20 - 29/30, 31 - 42  
Width: Medium  
3D-Contour: F = flat  
C = moderate longitudinal arch support with flat heel  
Shell material: Freely selectable  
(see overview acrylic fiber composite sheets)



ACRYLIC 114  
MATERIAL: G422



# ACRYL 108

## CHARACTERISTICS

- Corrective foot orthotic blank with lateral heel flange

## PRODUCT FACTS

Size range: 20 - 42  
Width: Medium  
3D-Contour: F = flat  
D = moderate longitudinal arch support with slightly guided heel  
Shell material: Freely selectable  
(see overview acrylic fiber composite sheets)



ACRYLIC 108  
MATERIAL: GH501



---

# ACRYL 109

## CHARACTERISTICS

- Corrective foot orthotic blank with lateral heel flange

## PRODUCT FACTS

Size range: 17 - 43  
Width: Medium  
3D-Contour: F = flat  
G = low longitudinal arch support  
A2 = high longitudinal arch support with slightly guided heel cup  
Shell material: Freely selectable  
(see overview acrylic fiber composite sheets)



ACRYLIC 109  
MATERIAL: HGH531

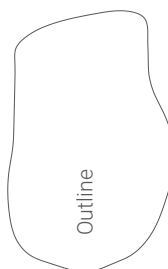

# ACRYL 110

## CHARACTERISTICS

- Corrective foot orthotic blank with lateral heel flange

## PRODUCT FACTS

Size range: 20 - 46

Width: Medium

3D-Contour: F = flat

B = moderate longitudinal arch support with slightly guided heel cup

Shell material: Freely selectable  
(see overview acrylic fiber composite sheets)



ACRYLIC 110  
MATERIAL: HGH531

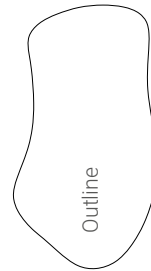



# SHOE/INSOLE STIFFENERS





## SHOE/INSOLE STIFFENERS

SHOE STIFFENERS / REINFORCEMENTS made from Perpedes' fiber composite materials serve to protect or immobilize foot or toe joints in the shoe. This requires stiffening of the shoe's flexible parts, e.g. the outsole. Ideally, the existing sole is cut open, the stiffening layer is incorporated and a functionally compensating rocker-sole is provided. SHOE STIFFENERS/REINFORCEMENTS can be chosen from a variety of Perpedes' glass and carbon fiber composite materials and outlines. They can be optionally shaped at a maximum of 140°C and are, therefore, uniquely adapted to the user's shoe.

SHOE STIFFENER 179

Page 168

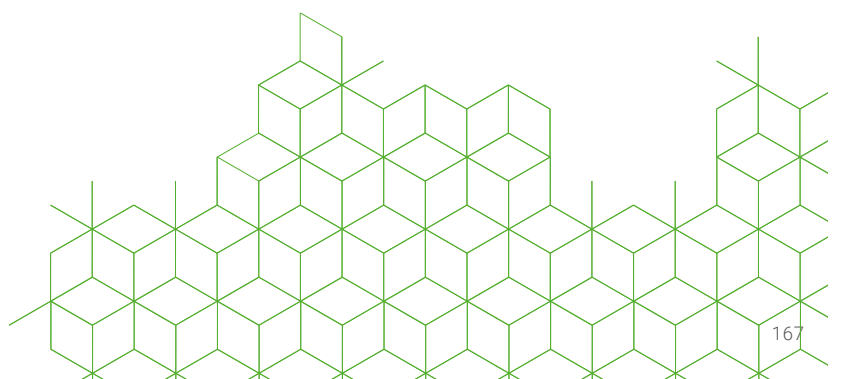

Perpedes  
4YOU

Self-supporting  
foot orthoses

Accommodative  
foot orthoses

Heel cupped  
foot orthoses

Sensomotoric  
foot orthoses

Self-supporting  
orthotic shells

Shoe / insole  
stiffeners

Top covers

Cushion  
materials

Top layers  
combinations

Base / bottom  
covers

Acrylic  
fiber composite  
sheets

Balancer /  
met pads

Cushion  
and pads

Assessment

Good to know

# SHOE STIFFENER 179

## CHARACTERISTICS

- Shoe/insole stiffeners

## PRODUCT FACTS

Size range: 18 -45  
Width: Broad  
3D-Contour: F = flat  
V= slight heel spring with flat heel  
Shell material: Freely selectable  
(see overview acrylic fiber composite sheets)



ACRYLIC 179  
MATERIAL: BF7003



---

# SHOE STIFFENER 180

## CHARACTERISTICS

- Shoe/insole stiffeners

## PRODUCT FACTS

Size range: 37 - 48  
Width: Medium  
3D-Contour: F = flat  
V= slight heel spring with flat heel  
Shell material: Freely selectable  
(see overview acrylic fiber composite sheets)



ACRYLIC 180  
MATERIAL: G422



# SHOE STIFFENER 181

## CHARACTERISTICS

- Shoe/insole stiffeners

## PRODUCT FACTS

Size range: 35 - 48  
Width: Narrow  
3D-Contour: F = flat  
V= slight heel spring with flat heel  
Shell material: Freely selectable  
(see overview acrylic fiber composite sheets)



ACRYLIC 181  
MATERIAL: G422





# MATERIALS



# TOP COVERS

# CLARINO NASH

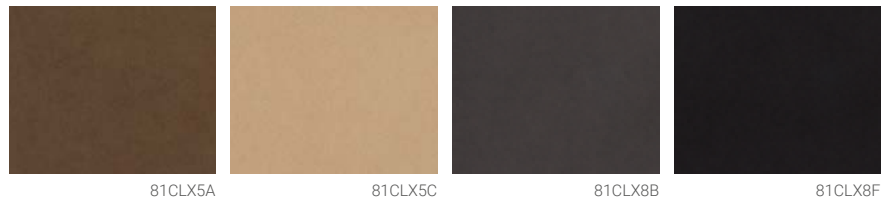

## MATERIAL COMPOSITION

60% PA / 40% PUR

## CHARACTERISTICS

- Antibacterial
- Breathable
- Water vapor permeable
- Washable



**NOTE:** Product is due to its antibacterial property cytotoxic

## PROCESSING

- Can be easily glued, cut, molded and ground
- Recommended for less profiled surfaces due to its strength

## DELIVERY FORM

- Available as yard goods/roll (width approx. 140 cm) approx. 50 rmt
- Available as mini roll (width approx. 12 cm) approx. 50 rmt 
- Available as top layer combination (see top layer combinations Clarino Nash+)

ITEM NO. <b>OLD</b>	ITEM NO. <b>NEW</b>	COLOR	TEXTUR	THICKNESS	
81CL50	81CLX5A	brown	-	0.6 mm	
81CL52	81CLX5C	beige	-	0.6 mm	
81CL82	81CLX8B	grey	-	0.6 mm	
81CL86	81CLX8F	anthracite	-	0.6 mm	

# DRYFEET smooth



## MATERIAL COMPOSITION

66% PA / 5% PUR / 29% PES

## CHARACTERISTICS









- Very high abrasion resistance
- Breathable
- Very good moisture absorption and release
- Feel and look like leather
- Very good tear resistance and tensile strength
- Selected colors available with eucalyptus finish

## PROCESSING

- Can be easily glued, cut and ground

## DELIVERY FORM

- Available as yard goods/roll (width approx. 137 cm) approx. 50 rmt
- Available as mini roll (width approx. 12cm) approx. 50 rmt 
- Available as top layer combination (see top layer combinations DryFeet+)

ITEM NO. OLD	ITEM NO. NEW	COLOR	TEXTUR	THICKNESS	
81DF32	81DFX3C	aqua	smooth	0.8 mm	
81DF37	81DFX3H	purple	smooth	0.8 mm	
81DF40	81DFX4A	apple	smooth	0.8 mm	
81DF36	81DFX3G	dark blue	smooth	0.8 mm	
81DF52	81DFX5C	beige	smooth	0.8 mm	
81DF61	81DFX5L	nature	smooth	0.8 mm	
81DF50	81DFX5A	brown	smooth	0.8 mm	
81DF80	81DFX8A	black	smooth	0.8 mm	
81DF86	81DFX8F	anthracite	smooth	0.8 mm	

# DRYFEET finely perforated

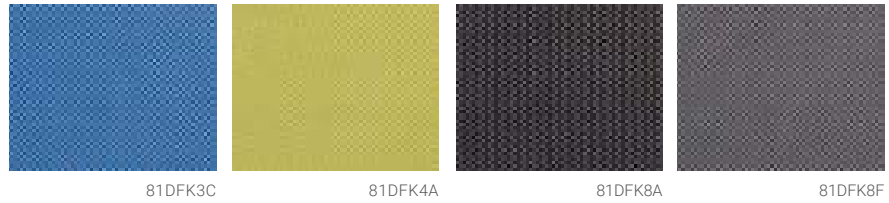

## MATERIAL COMPOSITION

66% PA / 5% PUR / 29% PES

## CHARACTERISTICS

- Very high abrasion resistance
- Breathable
- Very good moisture absorption and release
- Feel and look like leather
- Very good tear resistance and tensile strength
- Selected colors available with eucalyptus finish

## PROCESSING

- Can be easily glued (spray glue recommended), cut and ground

## DELIVERY FORM

- Available as yard goods/roll (width approx. 137 cm) approx. 50 rmt
- Available as top layer combination (see top layer combinations DryFeet+)

ITEM NO. <b>OLD</b>	ITEM NO. <b>NEW</b>	COLOR	TEXTUR	THICKNESS
81DF32K	81DFK3C	aqua	finely perforated	0.8 mm
81DF40K	81DFK4A	apple	finely perforated	0.8 mm
81DF80K	81DFK8A	black	finely perforated	0.8 mm
81DF86K	81DFK8F	anthracite	finely perforated	0.8 mm

# DRYFEET microperforated

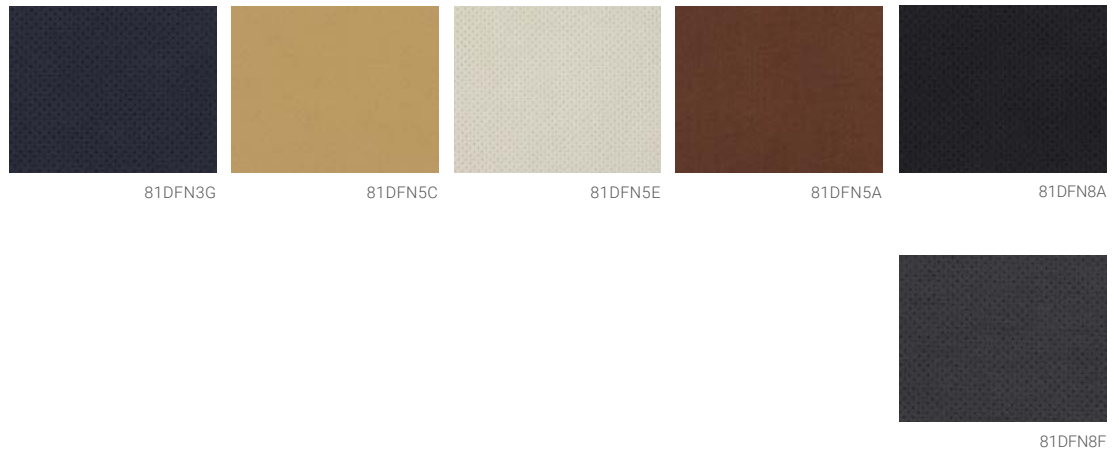

## MATERIAL COMPOSITION

66% PA / 5% PUR / 29% PES

## CHARACTERISTICS

- Very high abrasion resistance
- Breathable
- Very good moisture absorption and release
- Feel and look like leather
- Very good tear resistance and tensile strength
- Selected colors available with eucalyptus finish

## PROCESSING

- Can be easily glued, cut and ground

## DELIVERY FORM

- Available as yard goods/roll (width approx. 137 cm) approx. 50 rmt
- Available as mini roll (width approx. 12cm) approx. 50 rmt
- Available as top layer combination (see top layer combinations DryFeet+)

ITEM NO. <b>OLD</b>	ITEM NO. <b>NEW</b>	COLOR	TEXTUR	THICKNESS	
81DF36N	81DFN3G	dark blue	microperforated	0.8 mm	
81DF52N	81DFN5C	beige	microperforated	0.8 mm	
	81DFN5E	pebble	microperforated	0.8 mm	
81DF50N	81DFN5A	brown	microperforated	0.8 mm	
81DF80N	81DFN8A	black	microperforated	0.8 mm	
81DF86N	81DFN8F	anthracite	microperforated	0.8 mm	

# DRYFEET EUCALYPTUS

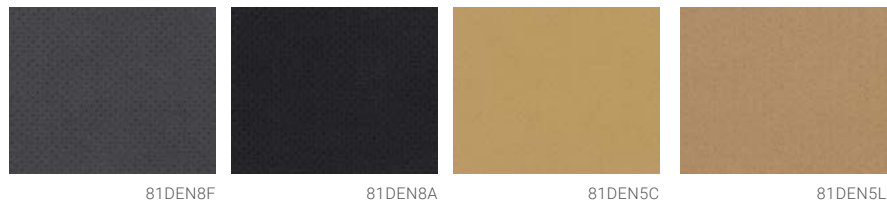

## MATERIAL COMPOSITION

66% PA / 5% PUR / 29% PES

## CHARACTERISTICS



- Very high abrasion resistance
- Breathable
- Very good moisture absorption and release
- Feel and look like leather
- Very good tear resistance and tensile strength
- Selected colors available with eucalyptus finish

## PROCESSING

- Can be easily glued, cut and ground

## DELIVERY FORM

- Available as yard goods/roll (width approx. 137 cm) approx. 50 rmt
- Available as mini roll (width approx. 12cm) approx. 50 rmt 
- Available as top layer combination (see top layer combinations DryFeet+)

ITEM NO. OLD	ITEM NO. NEW	COLOR	TEXTUR	THICKNESS	
81DE86N	81DEN8F	EUCALYPTUS anthracite	microperforated	0.8 mm	
81DE80N	81DEN8A	EUCALYPTUS black	microperforated	0.8 mm	
81DE52N	81DEN5C	EUCALYPTUS beige	microperforated	0.8 mm	
81DE61N	81DEN5L	EUCALYPTUS nature	microperforated	0.8 mm	

# NETTEX<sup>2</sup>

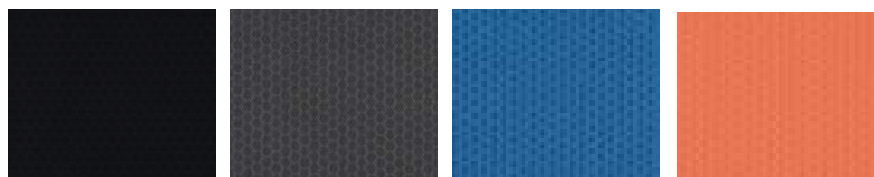

81NTX8AV

81NTX8FV

81NTX3IV

81NTX1BV

## MATERIAL COMPOSITION

100% PES

Laminated with nonwoven 50g/qm black

Pre-treated with spray adhesive

## CHARACTERISTICS

- Very high abrasion resistance
- Antibacterial
- Breathable
- Odor inhibiting





NOTE: Product is due to its antibacterial property cytotoxic

## PROCESSING

- Can be easily glued, cut or punched
- Frays during grinding (flame-scarfing recommended)

## DELIVERY FORM

- Available as yard goods/roll (width approx. 148 cm) approx. 50 rmt
- Available as mini roll (width approx. 12 cm) approx. 50 rmt 

ITEM NO. <b>OLD</b>	ITEM NO. <b>NEW</b>	COLOR	TEXTUR	THICKNESS	
81NN80V	81NTX8AV	black	-	0.85 mm	
81NN86V	81NTX8FV	anthracite	-	0.85 mm	
81NN38V	81NTX3IV	blue	-	0.85 mm	
81NN11V	81NTX1BV	orange	-	0.85 mm	

# NUBUTEX

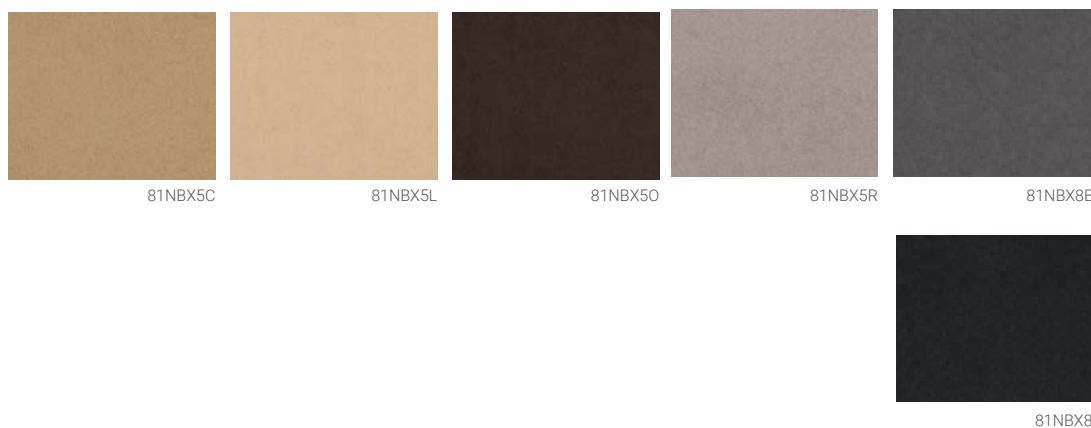

## MATERIAL COMPOSITION

100% PA

## CHARACTERISTICS

- Very high abrasion resistance
- Antibacterial
- Breathable
- Thermoregulating characteristics



## PROCESSING

- Can be easily glued, cut, punched and molded

## DELIVERY FORM

- Available as yard goods/roll (width approx. 137 cm) approx. 50 rmt
- Available as mini roll (width approx. 12 cm) approx. 50 rmt 

NOTE: Product is due to its antibacterial property cytotoxic

ITEM NO. OLD	ITEM NO. NEW	COLOR	TEXTUR	THICKNESS	
81NB52	81NBX5C	beige	-	0.8 mm	
81NB61	81NBX5L	nature	-	0.8 mm	-
81NB64	81NBX50	chocolate	-	0.8 mm	
81NB69	81NBX5R	taupe	-	0.8 mm	
81NB82	81NBX8B	anthracite	-	0.8 mm	
81NB80	81NBX8A	black	-	0.8 mm	

# PERPEDES PUR NAPPA



81NPG5C

81NPF8A

81NPG8A

## MATERIAL COMPOSITION

60% PUR / 40% Viscose

## CHARACTERISTICS

- High abrasion resistance
- Antibacterial
- Breathable
- Water vapour permeable
- Elastic





**NOTE:** Product is due to its antibacterial property cytotoxic

## PROCESSING

- Can be easily glued, cut and ground

## DELIVERY FORM

- Available as yard goods/roll (width approx. 145 cm) approx. 50 rmt
- Available as mini roll (width approx. 12 cm) approx. 50 rmt 
- Available as top layer combination (see top layer combinations Perpedes Pur Nappa+)

ITEM NO. <b>OLD</b>	ITEM NO. <b>NEW</b>	COLOR	TEXTUR	THICKNESS	
81NP52G	81NPG5C	beige	embossed	0.65 mm	
81NP80F	81NPF8A	black	finely embossed	0.65 mm	
81NP80G	81NPG8A	black	embossed	0.65 mm	

# SKINLIFE

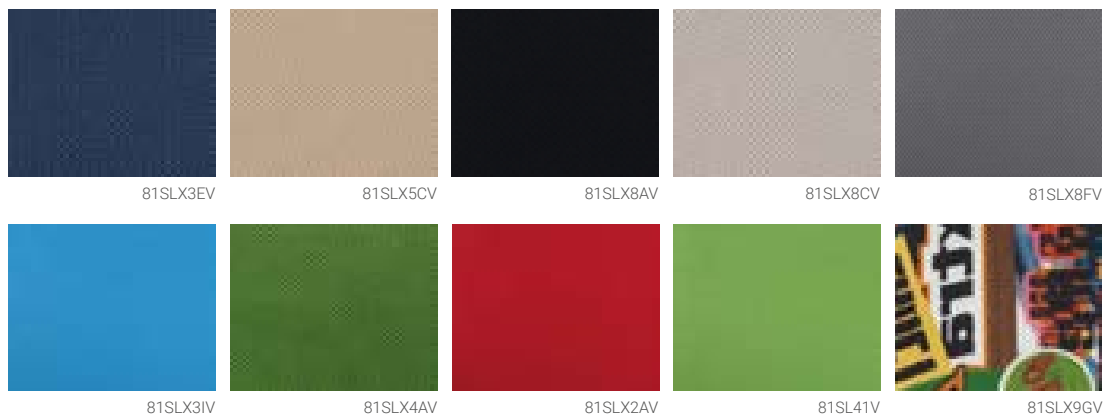

## MATERIAL COMPOSITION

50% PUR / 50% PA

- Laminated with nonwoven 50g/qm black
- Pre-treated with spray adhesive

## CHARACTERISTICS

- Antimicrobial (allergy friendly)
- Excellent moisture transfer
- Breathable, water vapour permeable
- Comfortable, skin-friendly surface
- Good tensile strength









## PROCESSING

- Can be easily glued

## DELIVERY FORM

- Available as yard goods/roll (width 140 cm) approx. 50 rmt
- Available as mini roll (width 12 cm) approx. 50 rmt 

**NOTE:** Product is due to its antibacterial property cytotoxic

ITEM NO. OLD	ITEM NO. NEW	COLOR	TEXTUR	THICKNESS	
81SL34V	81SLX3EV	denim	-	0.8 mm	
81SL52V	81SLX5CV	beige	-	0.8 mm	
81SL80V	81SLX8AV	black	-	0.8 mm	
81SL83V	81SLX8CV	silver	-	0.8 mm	
81SL86V	81SLX8FV	anthracite	-	0.8 mm	-
81SL38V	81SLX3IV	blue	-	0.8 mm	
81SL40V	81SLX4AV	green	-	0.8 mm	
81SL20V	81SLX2AV	red	-	0.8 mm	
81SL41V12*	-	lime	-	0.8 mm	
81SLPR1V	81SLX9GV	printed	-	0.8 mm	

\*only available as mini roll

# SKINLIFE printed



## MATERIAL COMPOSITION

50% PUR + 50% PA  
Laminated with nonwoven 50g/qm white

## CHARACTERISTICS

- Antimicrobial (allergy friendly)
- Excellent moisture transfer
- Breathable, water vapour permeable
- Comfortable, skin-friendly surface
- Good tensile strength





## PROCESSING

- Can be easily glued

## DELIVERY FORM

- Available as top cover with configured insoles
- Available as mini roll (width 12 cm) approx. 50 rmt 

NOTE: Product is due to its antibacterial property cytotoxic

ITEM NO.	COLOR	TEXTUR	THICKNESS	
81SLXDA	SKINLIFE, Splash	-	0.8 mm	
81SLXDB	SKINLIFE, Dino	-	0.8 mm	
81SLXDC	SKINLIFE, Berry	-	0.8 mm	
81SLXDD	SKINLIFE, Faces	-	0.8 mm	

Perpedes 4YOU  
 Self-supporting foot orthoses  
 Accomodative foot orthoses  
 Heel cupped foot orthoses  
 Sensomotoric foot orthoses  
 Self-supporting orthotic shells  
 Shoe / insole stiffeners  
 Cushion materials  
 Top layers combinations  
 Base / bottom covers  
 Acrylic fiber composite sheets  
 Balancer / met pads  
 Cushion and pads  
 Assessment  
 Good to know

Top covers



# LEATHER

# SLEEK LEATHER



82BLXB

## MATERIAL COMPOSITION

100 % Cowhide leather

## CHARACTERISTICS

- Vegetable tanned
- Chromium-free
- Lightly greased natural cowhide leather
- Color natur

## PROCESSING

- Leather typical
- Can be easily glued and punched

## DELIVERY FORM

- Available as whole skin

**NOTE:** Material of animal origin

ITEM NO. <b>OLD</b>	ITEM NO. <b>NEW</b>	COLOR	TEXTUR	THICKNESS
82BL17	82BLXB	naturell	-	1.6 - 1.8 mm

# CALFSKIN LEATHER LINING

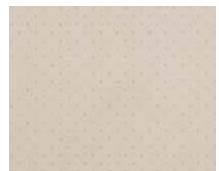

82KFGA

## MATERIAL COMPOSITION

100 % Calf leather

## CHARACTERISTICS

- Dyed with aniline
- Soft calf leather
- Chrome tanned

## PROCESSING

- Leather typical
- Can be easily glued and punched

## DELIVERY FORM

- Available as whole skin

**NOTE:** Material of animal origin

ITEM NO. <b>OLD</b>	ITEM NO. <b>NEW</b>	COLOR	TEXTUR	THICKNESS
82KFG	82KFGA	beige (anilin)	embossed	0.8 - 1.0 mm

# COWHIDE LEATHER LINING

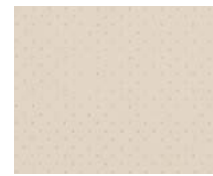

82RCGA

## MATERIAL COMPOSITION

100 % Cowhide leather

## CHARACTERISTICS

- Chromium-free tanning
- Skin-friendly
- Soft cowhide leather lining
- Durable
- Unembossed and embossed available

## PROCESSING

- Leather typical
- Can be easily glued and punched

## DELIVERY FORM

- Available as whole skin
- Available as top layer combination (see top layer combinations leather+)

NOTE: Material of animal origin

ITEM NO. OLD	ITEM NO. NEW	COLOR	TEXTUR	THICKNESS
82RCFG	82RCGA	natural	embossed	1.0 - 1.2 mm

# SOFT SPLIT COWHIDE LEATHER

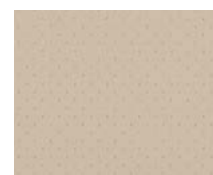

82RSGA

## MATERIAL COMPOSITION

100 % Split Cowhide leather

## CHARACTERISTICS

- Unembossed and embossed available
- Soft split cowhide leather
- Chrome tanned

## PROCESSING

- Leather typical
- Can be easily glued and punched

## DELIVERY FORM

- Available as whole skin
- Available as top layer combination (see top layer combinations leather+)

NOTE: Material of animal origin

ITEM NO. OLD	ITEM NO. NEW	COLOR	TEXTUR	THICKNESS
82RSG	82RSGA	off-white	embossed	0.6 - 0.8 mm



# CUSHION MATERIALS

# PERPEDES EVA FOAM

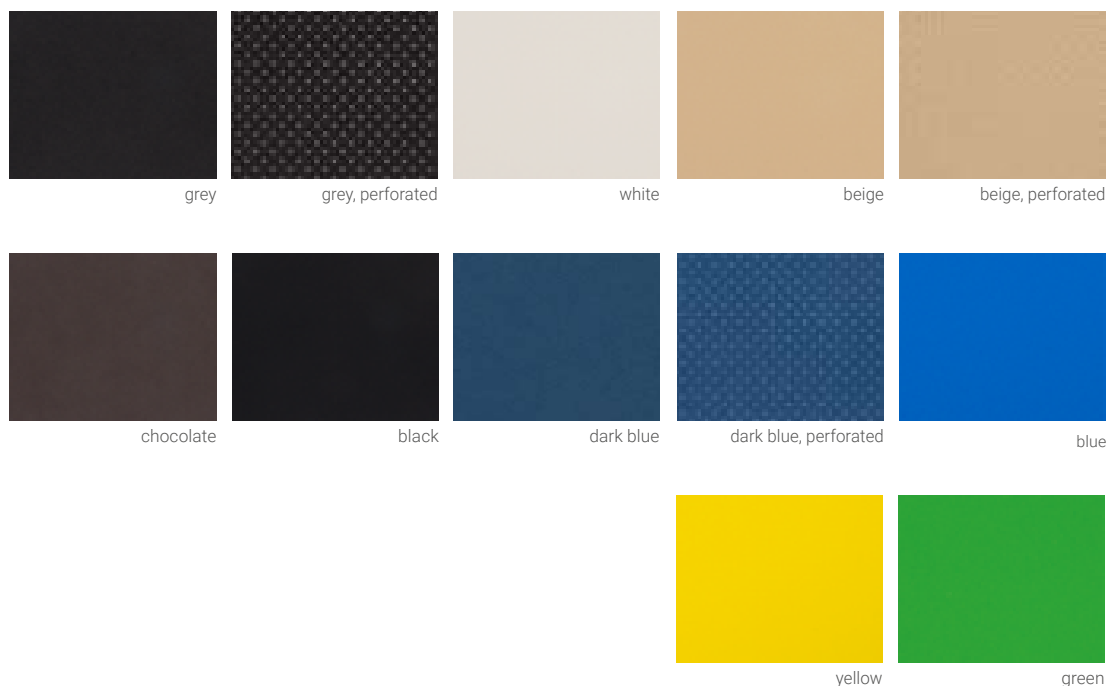

## MATERIAL COMPOSITION

90% EVA / 10% SBR (20°, 25° and 30° Shore A)  
 100 % EVA (40° and 50° Shore A)

## CHARACTERISTICS

- Closed cell structure
- Soft
- High resilience
- Disinfectable and surface washable
- Good cushioning characteristics
- Very good tear resistance
- Tolerance approx. +/- 5° Shore A

## APPLICATION

- For area relief of pressure-sensitive surfaces

## PROCESSING

- Can be easily cut, ground, milled and punched
- Very good adhesive properties
- Good deformability

## DELIVERY FORM

- Available as sheet
- Available as pre-cut pairs\*
- Available as top layer combination

## SHORE 20°

Minimum sheet size: 204 x 97 cm

ITEM NO. OLD	ITEM NO. NEW	COLOR	TEXTURE	SHORE	THICKNESS
83EVA20280	83EVA20028A	black	-	20° Shore A	2.0 mm
83EVA20380*	83EVA20038A	black	-	20° Shore A	3.0 mm
83EVA20880	83EVA20088A	black	-	20° Shore A	8.0 mm
83EVA20280P	83EVP20028A	black	perforated	20° Shore A	2.0 mm
83EVA20881	83EVA20086A	white	-	20° Shore A	8.0 mm

## SHORE 25°

Minimum sheet size: 204 x 97 cm

ITEM NO. OLD	ITEM NO. NEW	COLOR	TEXTURE	SHORE	THICKNESS
83EVA252	83EVA25025C	beige	-	25° Shore A	2.0 mm
83EVA252P	83EVP25025C	beige	perforated	25° Shore A	2.0 mm
83EVA253	83EVA25035D	beige	-	25° Shore A	3.0 mm
83EVA254*	83EVA25045C	beige	-	25° Shore A	4.0 mm
83EVA254P*	83EVP25045C	beige	perforated	25° Shore A	4.0 mm
	83EVP25045O	choco	perforated	25° Shore A	4.0 mm
83EVA25480*	83EVA25048A	black	-	25° Shore A	4.0 mm
83EVA25680*	83EVA25068A	black	-	25° Shore A	6.0 mm
	83EVA25023A	blue	-	25° Shore A	2.0 mm
	83EVA25033A	blue	-	25° Shore A	3.0 mm

## SHORE 35°

Minimum sheet size: 195 x 92 cm

ITEM NO. OLD	ITEM NO. NEW	COLOR	TEXTURE	SHORE	THICKNESS
83EVA35233	83EVA35023D	dark blue	-	35° Shore A	2.0 mm
83EVA35333	83EVA35033D	dark blue	-	35° Shore A	3.0 mm
83EVA35433*	83EVA35043D	dark blue	-	35° Shore A	4.0 mm
83EVA35433P	83EVP35043D	dark blue	perforated	35° Shore A	4.0 mm
83EVA35533	83EVA35033D	dark blue	-	35° Shore A	5.0 mm
	83EVA35053D	dark blue	-	35° Shore A	5.0 mm
83EVA35633	83EVA35063D	dark blue	-	35° Shore A	6.0 mm
	83EVA35021A	yellow	-	35° Shore A	2.0 mm
83EVA35310*	83EVA35031A	yellow	-	35° Shore A	3.0 mm
83EVA35382	83EVA35038B	grey	-	35° Shore A	3.0 mm
83EVA35482P	83EVP35048B	grey	perforated	35° Shore A	4.0 mm

## SHORE 40°

Minimum sheet size: 204 x 97 cm

ITEM NO. OLD	ITEM NO. NEW	COLOR	TEXTURE	SHORE	THICKNESS
83EVA4010*	83EVA40101A	white	-	40° Shore A	10.0 mm
83EVA4012	83EVA40126A	white	-	40° Shore A	12.0 mm
83EVA401080	83EVA40108A	black	-	40° Shore A	10.0 mm
	83EVA40128A	black	-	40° Shore A	12.0 mm

## SHORE 50°/55°

Minimum sheet size: 102 x 77 cm (50°)

204 x 97 cm (55°)

ITEM NO. OLD	ITEM NO. NEW	COLOR	TEXTURE	SHORE	THICKNESS
83EVA5015	83EVA50518A	black	-	50° Shore A	1.5 mm
83EVA50380	83EVA50038A	black	-	50° Shore A	3.0 mm
83EVA551542	83EVA55514C	green	-	55° Shore A	1.5 mm
83EVA551533	83EVA55513D	dark blue	-	55° Shore A	1.5 mm

# PERPEDES EVA PLUS FOAM

## >> PERPEDES EVA COMFORT FOAM



### MATERIAL COMPOSITION

85% EVA / 15% SBR

### CHARACTERISTICS

- Closed cell structure
- Very soft
- Very high resilience
- Disinfectable and surface washable
- Very good cushioning characteristics
- Very good tear resistance
- Tolerance approx. +/- 5° Shore A

### APPLICATION

- For punctual and area relief of pressure-sensitive surfaces

### PROCESSING

- Can be easily cut, ground, milled and punched
- Very good adhesive properties
- Good deformability

### DELIVERY FORM

- Available as sheet (Minimum size: 204 x 97 cm)  
83EVA20034A (Minimum size: 132,30 x 88,20 cm)

ITEM NO. OLD	ITEM NO. NEW	COLOR		TEXTURE	SHORE	THICKNESS
83EVA20034A	83EVA25034A	green	<b>NEW</b>	-	25° Shore A	3.0 mm
83EVA20031B	83EVA25031B	orange	<b>NEW</b>	-	25° Shore A	3.0 mm
83EVA20032A	83EVA25032A	red	<b>NEW</b>	-	25° Shore A	3.0 mm
83EVA20340	83EVA20034A	green	<b>SALE</b>	-	25° Shore A	3.0 mm

# EVA ESD FOAM



black

## MATERIAL COMPOSITION

100% EVA with antistatic agent

## CHARACTERISTICS

- Antistatic
- Closed cell structure
- Soft
- High resilience
- Disinfectable and surface washable
- Good cushioning characteristics
- Very good tear resistance
- Tolerance approx. +/- 5° Shore A

## APPLICATION

- For punctual and area relief of pressure-sensitive surfaces
- To use only with antistatic adhesives

## PROCESSING

- Can be easily cut, ground, milled and punched
- Very good adhesive properties
- Good deformability

## DELIVERY FORM

- Available as sheet (Minimum size: 102 x 77 cm)

ITEM NO. <b>OLD</b>	ITEM NO. <b>NEW</b>	COLOR	TEXTURE	SHORE	THICKNESS
83EVA501580A	83EVE50518A	black	-	50° Shore A	1.5 mm
83EVA50680A	83EVE50068A	black	-	50° Shore A	6.0 mm
83EVA501080A	83EVE50108A	black	-	50° Shore A	10.0 mm

# LUNAIRMED



beige

## MATERIAL COMPOSITION

100 % EVA

## CHARACTERISTICS

- Closed cell structure
- Disinfectable and surface washable
- Very soft
- Very good cushioning characteristics
- Average tear resistance

## APPLICATION

- For punctual and area relief of pressure-sensitive surfaces

## PROCESSING

- Can be easily cut, ground, milled and punched
- Very good adhesive properties
- Thermally deformable at 110° - 130°C

## DELIVERY FORM

- Available as sheet (approx. 82 x 108 cm)

ITEM NO. OLD	ITEM NO. NEW	COLOR	TEXTURE	SHORE	THICKNESS
83LM3	83LMX18035C	beige	-	18° Shore A	3.0 mm

# LUNALASTIK



beige

## MATERIAL COMPOSITION

100 % EVA

## CHARACTERISTICS

- Closed cell structure
- Disinfectable and surface washable
- Soft
- Good cushioning characteristics
- High resilience

## APPLICATION

- For punctual and area relief of pressure-sensitive surfaces

## PROCESSING

- Can be easily cut, ground, milled and punched
- Very good adhesive properties
- Thermally deformable at 110° - 130°C

## DELIVERY FORM

- Available as sheet (approx. 85 x 122 cm)

ITEM NO. OLD	ITEM NO. NEW	COLOR	TEXTURE	SHORE	THICKNESS
83LL3	83LLX25035C	beige	-	25° Shore A	3.0 mm
83LL6	83LLX25065C	beige	-	25° Shore A	6.0 mm

# LUNATEC MOTION

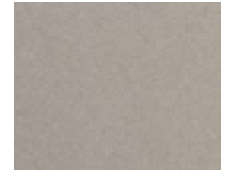

anthracite

## MATERIAL COMPOSITION

EVA copolymer

## CHARACTERISTICS

- Closed cell structure
- Very soft
- Elastic
- Disinfectable and surface washable
- Very high resilience
- Very good cushioning characteristics
- Tolerance approx. +/- 5° Shore A

## APPLICATION

- Top cover for foot orthoses, e.g. on to firm polypropylene shells

## PROCESSING

- Can be easily cut, ground, milled and punched
- Very good adhesive properties

## DELIVERY FORM

- Available as sheet (approx. 110 x 70 cm)

ITEM NO. <b>OLD</b>	ITEM NO. <b>NEW</b>	COLOR	TEXTURE	SHORE	THICKNESS
83LT2	83LTX10028F	anthracite	-	10° Shore A	2.0 mm
83LT3	83LTX10038F	anthracite	-	10° Shore A	3.0 mm

# PUR-MEMORY FOAM



## MATERIAL COMPOSITION

100% PUR

## CHARACTERISTICS

- Open cell structure
- Breathable and antimicrobial
- Soft
- Low resilience
- Good impact absorption
- Good cushioning characteristics

## APPLICATION

- For punctual and area relief of pressure-sensitive surfaces

## PROCESSING

- Can be easily cut, ground, milled and punched
- Very good adhesive properties
- Good deformability

## DELIVERY FORM

- Available as yard goods (width approx. 137 cm)

ITEM NO. OLD	ITEM NO. NEW	COLOR	TEXTURE	SHORE	THICKNESS
83MM15	83MMX10514A	green	smooth/smooth	18° Shore A	1.5 mm
83MM1580	83MMX10518A	black	smooth/smooth	18° Shore A	1.5 mm
83MM2	83MMX10024A	green	smooth/smooth	18° Shore A	2.0 mm
83MM3	83MMX10034A	green	smooth/smooth	15° Shore A	3.0 mm
83MM380	83MMX10038A	black	smooth/rough	13° Shore A	3.0 mm
	83MMB10038A	black	<b>NEW</b> rough/rough	13° Shore A	3.0 mm
83MM330	83MMX10033A	blue	smooth/smooth	13° Shore A	3.0 mm
83MM4	83MMX10044A	green	smooth/smooth	13° Shore A	4.0 mm
83MM5	83MMX10054A	green	smooth/smooth	13° Shore A	5.0 mm
83MM6	83MMX10064A	green	smooth/smooth	13° Shore A	6.0 mm
83MM95	83MMX10594A	green	smooth/smooth	13° Shore A	9.5 mm

# PUR-SLOW-MEMORY FOAM



red

## MATERIAL COMPOSITION

100% PUR

## CHARACTERISTICS

- Open cell structure
- Breathable and antimicrobial
- Very soft
- Low resilience
- Good impact absorption
- Good cushioning characteristics

## APPLICATION

- For punctual and area relief of pressure-sensitive surfaces

## PROCESSING

- Can be easily cut, ground, milled and punched
- Very good adhesive properties
- Good deformability

## DELIVERY FORM

- Available as yard goods/roll (width approx. 137 cm)
- Available as top layer combination (see top layer combinations)

ITEM NO. OLD	ITEM NO. NEW	COLOR	TEXTURE	SHORE	THICKNESS
83SM25	83SMX12522A	red	-	12° Shore A	2.5 mm
83SM3	83SMX07032A	red	-	12° Shore A	3.0 mm
83SM5	83SMX12052A	red	-	12° Shore A	5.0 mm
83SM6	83SMX07062A	red	-	12° Shore A	6.0 mm

# SHOCK ABSORBER X

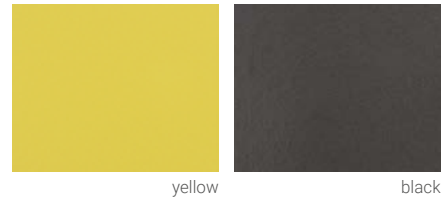

## MATERIAL COMPOSITION

100% PUR

## CHARACTERISTICS

- Open cell structure
- Breathable and antibacterial
- Extrem soft
- Low resilience
- Very good impact absorption (absorbs up to 90% of the energy)
- Very good cushioning characteristics

## APPLICATION

- For punctual and area relief of pressure-sensitive surfaces

## PROCESSING

- Can be easily cut, ground, milled and punched
- Very good adhesive properties
- Good deformability

## DELIVERY FORM

- Available as yard goods/roll (width approx. 137 cm)

ITEM NO. <b>OLD</b>	ITEM NO. <b>NEW</b>	COLOR	TEXTURE	SHORE	THICKNESS
83SA3	83SAX07031A	yellow	rough/smooth	7° Shore A	3.0 mm
83SA3B	83SAB07031A	yellow	rough/rough	7° Shore A	3.0 mm
83SA6	83SAX07061A	yellow	rough/smooth	7° Shore A	6.0 mm
83SA380X	83SAX12031A	black	rough/smooth	12° Shore A	3.0 mm

# PUR-MEDICAL FOAM



beige

## MATERIAL COMPOSITION

100% PUR

## CHARACTERISTICS

- Open cell structure
- Breathable and antimicrobial
- Very soft
- Low resilience
- Good impact absorption
- Good cushioning characteristics

## APPLICATION

- For punctual and area relief of pressure-sensitive surfaces

## PROCESSING

- Can be easily cut, ground, milled and punched
- Very good adhesive properties
- Good deformability

## DELIVERY FORM

- Available as yard goods/roll (width approx. 137 cm)
- Bough/rough available as sheet (approx. 100 x 137 cm)

ITEM NO. <b>OLD</b>	ITEM NO. <b>NEW</b>	COLOR	TEXTURE	SHORE	THICKNESS
83PPT15	83PPX12515D	beige	smooth/rough	14° Shore A	1.5 mm
	83PPB12515D	beige	<b>NEW</b> rough/rough	14° Shore A	1.5 mm
83PPT2B	83PPB12025D	beige	rough/rough	14° Shore A	2.0 mm
83PPT2	83PPX12025D	beige	smooth/rough	14° Shore A	2.0 mm
83PPT3B	83PPB12035D	beige	rough/rough	14° Shore A	3.0 mm
83PPT3	83PPX12035D	beige	smooth/rough	14° Shore A	3.0 mm
83PPT6	83PPX12065D	beige	smooth/rough	14° Shore A	6.0 mm



# TOP LAYER COMBINATIONS

# BI-STRETCH+



## DELIVERY FORM

- Available as sheet
- Available as pre-cut pairs

ITEM NO. OLD	ITEM NO. NEW	TOP COVER LAYER	CUSHIONING MATERIALS	THICKNESS	MINIMUM SIZE
V76	GB03	Bi-Stretch black, 0.6 mm	PUR Shock Absorber yellow, 8° Shore A, 3.0 mm	3.6 mm	135 cm wide
V73	GB01	Bi-Stretch beige, 0.6 mm	PUR Shock Absorber yellow, 8° Shore A, 3.0 mm	3.6 mm	135 cm wide
V74	GB02	Bi-Stretch black, 0.6 mm	PUR Shock Absorber black, 8° Shore A, 3.0 mm	3.6 mm	135 cm wide

# CLARINO NASH+



## DELIVERY FORM

- Available as sheet
- Available as pre-cut pairs

ITEM NO. OLD	ITEM NO. NEW	TOP COVER LAYER	CUSHIONING MATERIALS	THICKNESS	MINIMUM SIZE
V02	GC01	Clarino Nash beige, 0.6 mm	PUR-Memory green, 18° Shore A, 2.0 mm	2.6 mm	135 x 100 cm
V03	GC02	Clarino Nash beige, 0.6 mm	PUR-Memory green, 15° Shore A, 3.0 mm	3.6 mm	135 x 100 cm
V04	GC03	Clarino Nash beige, 0.6 mm	EVA beige, 25° Shore A, 4.0 mm	4.6 mm	204 x 97 cm
V14	GC04	Clarino Nash beige, 0.6 mm	EVA anthracite, 20° Shore A, 3.0 mm	3.6 mm	204 x 97 cm
V23	GC05	Clarino Nash grey, 0.6 mm	EVA anthracite, 20° Shore A, 3.0 mm	3.6 mm	204 x 97 cm
V27	GC08	Clarino Nash grey, 0.6 mm	PUR-Memory green, 18° Shore A, 1.5 mm	2.1 mm	135 x 100 cm
V25	GC06	Clarino Nash anthracite, 0.6 mm	EVA yellow, 35° Shore A, 3.0 mm	3.6 mm	195 x 92 cm
V26	GC07	Clarino Nash grey, 0.6 mm	EVA blue, 35° Shore A, 2.0 mm	2.6 mm	195 x 92 cm

# COOLMAX LYCRA+



## DELIVERY FORM

- Available as sheet
- Available as pre-cut pairs

ITEM NO. <b>OLD</b>	ITEM NO. <b>NEW</b>	TOP COVER LAYER	CUSHIONING MATERIALS	THICKNESS	MINIMUM SIZE
V91	G003	Coolmax Lycra black, 0.7 mm	PUR-Slow-Memory red, 12° Shore A, 3.0 mm	3.7 mm	135 x 100 cm
V81	G002	Coolmax Lycra black, 0.7 mm	PUR Shock Absorber yellow, 8° Shore A, 3.0 mm	3.7 mm	135 x 100 cm

# DRYFEET+ finely perforated

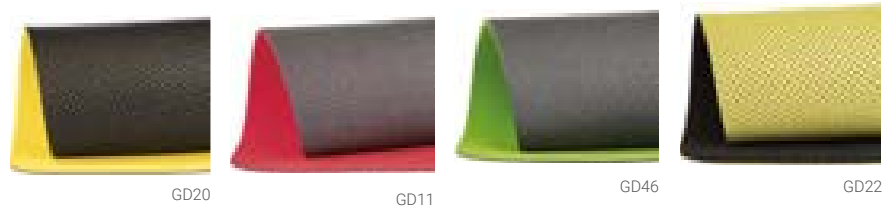

## DELIVERY FORM

- Available as sheet
- Available as pre-cut pairs

ITEM NO. <b>OLD</b>	ITEM NO. <b>NEW</b>	TOP COVER LAYER	CUSHIONING MATERIALS	THICKNESS	MINIMUM SIZE
V71	GD20	DryFeet black, finely perforated, 0.8 mm	EVA yellow, 35° Shore A, 3.0 mm	3.8 mm	195 x 92 cm
GD09	GD50	DryFeet anthracite, finely perforated, 0.8 mm	EVA COMFORT orange, 25° Shore A, 2.0 mm	2.8 mm	204 x 97 cm
GD10	GD46	DryFeet anthracite, finely perforated, 0.8 mm	EVA COMFORT green, 25° Shore A, 2.0 mm	<b>NEW</b> 2.8 mm	204 x 97 cm
V75	GD22	DryFeet apple, finely perforated, 0.8 mm	EVA black, 20° Shore A, 3.0 mm	3.8 mm	204 x 97 cm
V58	GD11	DryFeet anthracite, finely perforated, 0.8 mm	EVA PLUS red, 20° Shore A, 3.0 mm	3.8 mm	120 x 80 cm

Perpedes 4YOU  
 Self-supporting foot orthoses  
 Accomodative foot orthoses  
 Heel cupped foot orthoses  
 Sensomotoric foot orthoses  
 Self-supporting orthotic shells  
 Shoe / insole stiffeners  
 Top covers  
 Cushion materials  
 Top layers combinations  
 Base / bottom covers  
 Acrylic fiber composite sheets  
 Balancer / met pads  
 Cushion and pads  
 Assessment  
 Good to know

# DRYFEET+ microperforated



## DELIVERY FORM

- Available as sheet
- Available as pre-cut pairs

ITEM NO. OLD	ITEM NO. NEW	TOP COVER LAYER	CUSHIONING MATERIALS	THICKNESS	MINIMUM SIZE
GD01	GD56	DryFeet Eucalyptus anthracite, microperforated, 0.8 mm	EVA COMFORT red, 25° Shore A, 3.0 mm	<b>NEW</b> 3.8 mm	204 x 97 cm
GD05	GD55	DryFeet black, microperforated, 0.8 mm	EVA COMFORT red, 25° Shore A, 2.0 mm	<b>NEW</b> 2.8 mm	204 x 97 cm
V65	GD18	DryFeet black, microperforated, 0.8 mm	EVA black, 20° Shore A, 2.0 mm	2.8 mm	204 x 97 cm
V60	GD13	DryFeet black, microperforated, 0.8 mm	EVA black, 20° Shore A, 3.0 mm	3.8 mm	204 x 97 cm
V12	GD06	DryFeet black, microperforated, 0.8 mm	EVA grey, 35° Shore A, 3.0 mm	3.8 mm	195 x 92 cm
V61	GD14	DryFeet black, microperforated, 0.8 mm	EVA yellow, 35° Shore A, 3.0 mm	3.8 mm	195 x 92 cm
	GD49	DryFeet black, microperforated, 0.8 mm	EVA COMFORT green, 25° Shore A, 2.0 mm	2.8 mm	204 x 97 cm
V10	GD04	DryFeet black, microperforated, 0.8 mm	EVA blue, 35° Shore A, 2.0 mm	2.8 mm	195 x 92 cm
V89	GD29	DryFeet black, microperforated, 0.8 mm	PUR-Slow-Memory red, 12° Shore A, 2.5 mm	3.3 mm	135 x 100 cm
V87	GD27	DryFeet black, microperforated, 0.8 mm	PUR Shock Absorber X yellow, 7° Shore A, 3.0 mm	3.8 mm	135 x 100 cm
	GD61	DryFeet anthracite, microperforated, 0.8 mm	EVA COMFORT yellow, 25° Shore A, 2 mm	<b>NEW</b> 2.8 mm	204 x 97 cm
	GD48	DryFeet marine, microperforated, 0.8 mm	EVA COMFORT green, 25° Shore A, 2.0 mm	2.8 mm	204 x 97 cm
GD26	GD58	DryFeet marine, microperforated, 0.8 mm	EVA COMFORT red, 25° Shore A, 3.0 mm	<b>NEW</b> 3.8 mm	204 x 97 cm
	GD47	DryFeet anthracite, microperforated, 0.8 mm	EVA COMFORT green, 25° Shore A, 2.0 mm	2.8 mm	204 x 97 cm
	GD59	DryFeet anthracite, microperforated, 0.8 mm	EVA COMFORT green, 25° Shore A, 3.0 mm	3.8 mm	204 x 97 cm
	GD51	DryFeet anthracite, microperforated, 0.8 mm	EVA COMFORT orange, 25° Shore A, 2.0 mm	2.8 mm	204 x 97 cm
	GD60	DryFeet anthracite, microperforated, 0.8 mm	EVA COMFORT orange, 25° Shore A, 3.0 mm	3.8 mm	204 x 97 cm

# DRYFEET+ microperforated



## DELIVERY FORM

- Available as sheet
- Available as pre-cut pairs

ITEM NO. OLD	ITEM NO. NEW	TOP COVER LAYER	CUSHIONING MATERIALS	THICKNESS	MINIMUM SIZE
GD17	GD57	DryFeet anthracite, microperforated, 0.8 mm	EVA COMFORT red, 25° Shore A, 3.0 mm	<b>NEW</b> 3.8 mm	204 x 97 cm
V08	GD02	DryFeet anthracite, microperforated, 0.8 mm	EVA grey, 35° Shore A, 3.0 mm	3.8 mm	195 x 92 cm
V80	GD23	DryFeet brown, microperforated, 0.8 mm	EVA beige, 25° Shore A, 2.0 mm	2.8 mm	204 x 97 cm
	GD53	DryFeet pebble, microperforated, 0.8 mm	EVA blue, 25° Shore A, 2.0 mm	2.8 mm	204 x 97 cm
	GD54	DryFeet pebble, microperforated, 0.8 mm	EVA blue, 25° Shore A, 3.0 mm	3.8 mm	204 x 97 cm
V59	GD12	DryFeet beige, microperforated, 0.8 mm	EVA black, 20° Shore A, 3.0 mm	3.8 mm	204 x 97 cm
V09	GD03	DryFeet beige, microperforated, 0.8 mm	EVA blue, 35° Shore A, 2.0 mm	2.8 mm	195 x 92 cm

# EVA+

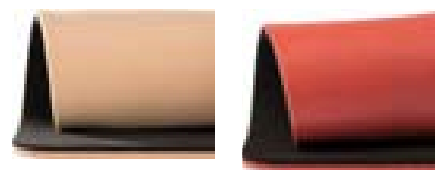

GP02

GP01

## DELIVERY FORM

- Available as sheet
- Available as pre-cut pairs

ITEM NO. OLD	ITEM NO. NEW	TOP COVER LAYER	CUSHIONING MATERIALS	THICKNESS	MINIMUM SIZE
V86	GP02	EVA anthracite, 20° Shore A, 2.0 mm	PUR-Medical beige, 12° Shore A, 3.0 mm	5.0 mm	135 x 100 cm
V83	GP01	EVA anthracite, 20° Shore A, 3.0 mm	Slow Memory red, 12° Shore A, 3.0 mm	6.0 mm	135 x 100 cm

# LEATHER+

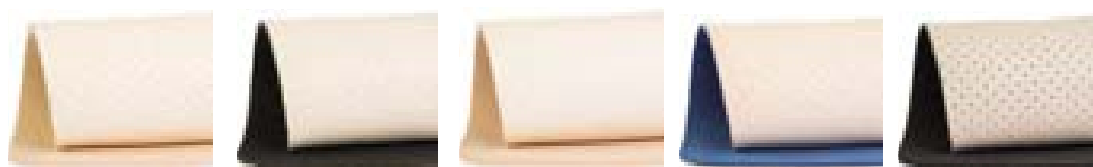

GL01

GL02

GL04

GL05

GL07

## DELIVERY FORM

- Available as pre-cut pairs

ITEM NO. OLD	ITEM NO. NEW	TOP COVER LAYER	CUSHIONING MATERIALS	THICKNESS
V41	GL01	Cowhide leather, perforated, 1.0 - 1.2 mm	EVA beige, 25° Shore A, 4.0 mm	5.0 - 5.2 mm
V42	GL02	Cowhide leather, perforated, 1.0 - 1.2 mm	EVA anthracite, 20° Shore A, 3.0 mm	4.0 - 4.2 mm
V45	GL04	Cowhide leather, perforated, 1.0 - 1.2 mm	PUR-Medical beige, 12° Shore A, 3.0 mm	4.0 - 4.2 mm
V47	GL05	Cowhide leather, perforated, 1.0 - 1.2 mm	EVA dark blue, 35° Shore A, 3.0 mm	4.0 - 4.2 mm
V50	GL07	Soft split cowhide leather, perforated, 0.6 - 0.8 mm	EVA anthracite, 20° Shore A, 3.0 mm	4.0 - 4.2 mm

# PERPEDES PUR NAPPA+



## DELIVERY FORM

- Available as sheet
- Available as pre-cut pairs

ITEM NO. OLD	ITEM NO. NEW	TOP COVER LAYER	CUSHIONING MATERIALS	THICKNESS	MINIMUM SIZE
V01	GN01	PERPEDES PUR Nappa beige, perforated, 0.65 mm	EVA dark blue, 35° Shore A, 2.0 mm	2.65 mm	195 x 92 cm
V13	GN03	PERPEDES PUR Nappa beige, perforated, 0.65 mm	EVA anthracite, 20° Shore A, 3.0 mm	3.65 mm	204 x 97 cm
V05	GN02	PERPEDES PUR Nappa black, perforated, 0.65 mm	EVA anthracite, 20° Shore A, 3.0 mm	3.65 mm	204 x 97 cm
V21	GN04	PERPEDES PUR Nappa black, perforated, 0.65 mm	EVA anthracite, 20° Shore A, 2.0 mm	2.65 mm	204 x 97 cm
V22	GN05	PERPEDES PUR Nappa black, perforated, 0.65 mm	EVA yellow, 35° Shore A, 3.0 mm	3.65 mm	195 x 92 cm
GN06	GN08	PERPEDES PUR Nappa black, perforated, 0.65 mm	EVA COMFORT red, 25° Shore A, 3.0 mm	<b>NEW</b> 3.65 mm	204 x 97 cm

# VELOURSTEX+



## DELIVERY FORM

- Available as sheet
- Available as pre-cut pairs

ITEM NO. OLD	ITEM NO. NEW	TOP COVER LAYER	CUSHIONING MATERIALS	THICKNESS	MINIMUM SIZE
V17	GV01	VeloursTex denim, 0.6 mm	EVA black, 20° Shore A, 3.0 mm	3.4 mm	204 x 97 cm

# ELTEN ESD PRO



GA02

## DELIVERY FORM

- Available as sheet (Minimum size: 35 x 25 cm)
- Available as foot orthose WORKER<sup>2</sup> Pro ELTEN, WORKER<sup>2</sup> CALCA ELTEN, WORKER<sup>2</sup> CPX ELTEN
- Available in connection with foot orthotic shell WORKER<sup>2</sup> BASE Pro, WORKER<sup>2</sup> BASE CALCA, WORKER<sup>2</sup> BASE CPX

ITEM NO.	TOP COVER LAYER	CUSHIONING MATERIALS	THICKNESS
GA02	ELTEN Logo	PU foam black, 35° Shore A	4 mm

# HAIX<sup>®</sup> CO SYSTEM



GA01

## DELIVERY FORM

- Available as sheet (Minimum size: 37 x 25 cm)
- Available combined with WORKER<sup>2</sup> PRO HAIX<sup>®</sup>, WORKER<sup>2</sup> CALCA HAIX<sup>®</sup>, WORKER<sup>2</sup> CPX HAIX<sup>®</sup>
- Available in connection with foot orthotic shell WORKER<sup>2</sup> BASE Pro, WORKER<sup>2</sup> BASE CALCA, WORKER<sup>2</sup> BASE CPX

ITEM NO.	TOP COVER LAYER	CUSHIONING MATERIALS	THICKNESS
GA01	HAIX <sup>®</sup> Logo	PU foam green, 35° Shore A	4 mm

# ATLAS KLIMA-KOMFORT®



GA04

## DELIVERY FORM

- Available as sheet (Minimum size: 34 x 24 cm)
- Available as foot orthose WORKER<sup>2</sup> PRO ATLAS, WORKER<sup>2</sup> CALCA ATLAS, WORKER<sup>2</sup> CPX ATLAS
- Available in connection with foot orthotic shell WORKER<sup>2</sup> BASE Pro, WORKER<sup>2</sup> BASE CALCA, WORKER<sup>2</sup> BASE CPX

ITEM NO.	TOP COVER LAYER	CUSHIONING MATERIALS	THICKNESS
GA04	ATLAS Logo	PU foam black, 15° Shore A	2.5 mm

# STEITZ SECURA ERGO-SOFT



GA03

## DELIVERY FORM

- Available as sheet (Minimum size: 39 x 29,5 cm)
- Available as foot orthose WORKER<sup>2</sup> PRO STEITZ SECURA, WORKER<sup>2</sup> CALCA STEITZ SECURA, WORKER<sup>2</sup> CPX STEITZ SECURA
- Available in connection with foot orthotic shell WORKER<sup>2</sup> BASE Pro, WORKER<sup>2</sup> BASE CALCA, WORKER<sup>2</sup> BASE CPX

ITEM NO.	TOP COVER LAYER	CUSHIONING MATERIALS	THICKNESS
GA03	Steitz Secura Logo	PU foam black, 15° Shore A	2.5 mm



# BASE/BOTTOM COVERS

# CARBOTEC

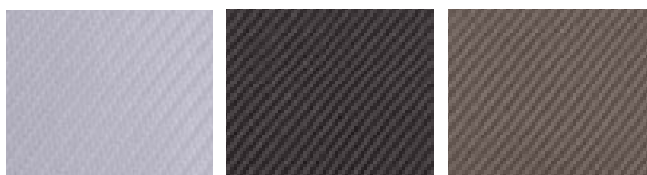

89CTXA8E

89CT8012

89CT8812

## MATERIAL COMPOSITION

50% PUR / 50% PA

## CHARACTERISTICS



- Carbon look
- High abrasion resistance
- Good tear resistance
- Slightly slip-resistant
- Colorfast and lightfast

## PROCESSING

- Can be easily glued, cut, ground, punched and molded
- Non-fraying
- Minimal shrinkage at 130°C

## DELIVERY FORM

- Available as yard goods/roll (width approx. 138 cm) approx. 50 rmt
- Available as mini roll (width approx. 12 cm) approx. 50 rmt 

ITEM NO. OLD	ITEM NO. NEW	COLOR	THICKNESS	
	89CTXA8E	silver	0.9 mm	
89CT8012		black	0.9 mm	
89CT8812		titanium	0.9 mm	

# PERPEDES PUR CARBON



89CLXA8A

## MATERIAL COMPOSITION

60% PUR / 40% Viscose

## CHARACTERISTICS

- Low abrasion resistance
- Good tear resistance
- Carbon look
- Colorfast and lightfast

## PROCESSING

- Can be easily glued, cut, ground and punched
- Thermoplastic conformable at 90° - 120°C (minimal shrinkage)
- Non-fraying

## DELIVERY FORM

- Available as yard goods/roll (width approx. 146 cm) approx. 50 rmt

ITEM NO. OLD	ITEM NO. NEW	COLOR	THICKNESS
89CL80	89CLXA8A	black	0.6 mm

# PUR



89PUV80HK

89PUV20HK

## MATERIAL COMPOSITION

100% PUR

## CHARACTERISTICS

- Laminated carrier nonwoven, hot-melt coating
- High abrasion resistance

## PROCESSING

- Can be easily glued and punched

## DELIVERY FORM

- Available as yard goods/roll (width approx. 150 cm) approx. 50 rmt

ITEM NO.	COLOR	THICKNESS
89PUV80HK	black	0.7 mm
89PUV20HK	red	0.8 mm

# TPU

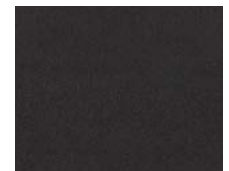

89TPXA8A

## CHARACTERISTICS

- Thermoplastic polyurethane
- High abrasion resistance
- Good deformability
- Good durability

## PROCESSING

- Can be easily glued, ground and punched
- Thermoplastic conformable at 90° - 120°C
- Very good adhesive properties due to light roughening of the surface

## DELIVERY FORM

- Available as yard goods/roll (width approx. 46 cm) approx. 60 rmt

ITEM NO.	COLOR	THICKNESS
89TPU	black	1.0 mm

# VILDONA NONWOVENS

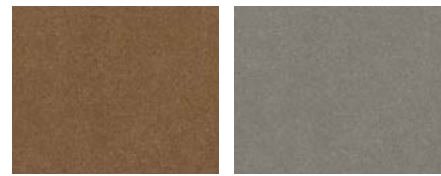

89VVUA5G

89VVP A8D

## CHARACTERISTICS

- High abrasion resistance
- Breathable
- Colorfast and lightfast
- With hot-melt coating

## PROCESSING

- Can be easily glued, cut, ground, punched and molded
- Non-fraying

## DELIVERY FORM

- Available as yard goods/roll (width approx. 148 cm) approx. 45 rmt

ITEM NO. <b>OLD</b>	ITEM NO. <b>NEW</b>	COLOR	THICKNESS
89VV55	89VVUA5G	cognac, pre-treated with hot-melt adhesive for polypropylene shells	0.85 mm
89VV84	89VVP A8D	smoke, pre-treated with hot-melt adhesive for acrylic/epoxy shells	0.85 mm

# NONWOVEN FLEECE

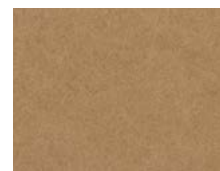

89VPXA5H

## CHARACTERISTICS

- Synthetic fleece
- High abrasion resistance
- Good tear resistance
- Absorbent
- Breathable and water vapour permeable

## PROCESSING

- Can be easily glued, cut, ground, punched and molded

## DELIVERY FORM

- Available as yard goods/roll (width approx. 150 cm) approx. 30 rmt

ITEM NO. <b>OLD</b>	ITEM NO. <b>NEW</b>	COLOR	THICKNESS
89VP05	89VVUA5G	brandy	0.5 mm

# FLEECE TEX

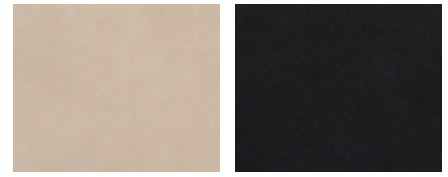

89VSA5E

89VSA8A

## CHARACTERISTICS

- Synthetic fleece
- High abrasion resistance
- Water vapour permeable
- Good moisture absorption and release
- Breathable
- Colorfast and lightfast

## PROCESSING

- Can be easily glued, cut, ground, punched and molded
- Non-fraying

## DELIVERY FORM

- Available as yard goods/roll (width approx. 150 cm) approx. 40 rmt

ITEM NO. <b>OLD</b>	ITEM NO. <b>NEW</b>	COLOR	THICKNESS
89VS54	89VSA5E	pebble	0.75 mm
89VS80	89VSA8A	black	0.75 mm



# CORK

Good to know

Assessment

Cushion and pads

Balancer / met pads

Acrylic fiber composite sheets

**Base / bottom covers**

Top layers combinations

Cushion materials

Top covers

Shoe / insole stiffeners

Self-supporting orthotic shells

Sensomotoric foot orthoses

Heel cupped foot orthoses

Accommodative foot orthoses

Self-supporting foot orthoses

Perpedes 4YOU

# THERMO CORK



89TKXA5L

89TKXB5L

## CHARACTERISTICS

- Dimensionally stable
- Easy to clean
- Lightweight
- 70° Shore A (2.5mm) / 55°-58° Shore A (12mm)

## PROCESSING

- Can be easily glued, cut and ground
- Thermoplastic conformable at 120°C

## DELIVERY FORM

- Available as sheet (2.5 mm: approx. 90 x 70 cm / 12 mm: approx. 114 x 166 cm)

ITEM NO. <b>OLD</b>	ITEM NO. <b>NEW</b>	COLOR	THICKNESS
89TK25	89TKXA5L	beige	2.5 mm
89KE12	89TKXB5L	beige	12.0 mm







## ACRYLIC FIBER COMPOSITE SHEETS

Perpedes acrylic composite materials made from glass and carbon fibers are manufactured exclusively in Germany and are used in foot orthotic shells, as shoe stiffeners and AFOs/DAFOs, among other applications. The composite materials consist of a transparent, thermoplastic acrylic resin as a matrix and combination of reinforcements made from polyester, polyamide, glass and/or carbon fibers. The product quality of the unique composite materials made from glass/carbon fiber could have been further developed and improved through decades of experience in manufacturing them. This has yielded further applications and new variants over time so that their usage in orthopedics/orthopedic shoe technology proves to be extremely variable. The optimal material for every application and for every desired characteristic regarding deformability behaviour, rigidity, material thickness and weight can always be found in the Perpedes portfolio. Advantages lie in the combination of different reinforcement types and materials: woven, roving and knitted. The continuous fibers are arranged in stitches in the knitted materials. Each individual stitch is a more or less taut fiber loop which can be lengthened or compressed. It can therefore absorb tensile stress, compression and transverse stress which gives the material its special deformability behaviour. In woven and roving materials, however, the reinforcing fibers are in a stretched condition. They therefore undergo less expansion under higher tensile loads than knitted materials and have high tensile strength and rigidity. Using taut knitted material brings both material properties to bear. With our state-of-the-art machines and sustainable operations, we have manufacturing processes available to us which ensures Perpedes' high standards of quality and synchronizes individual components with each other.

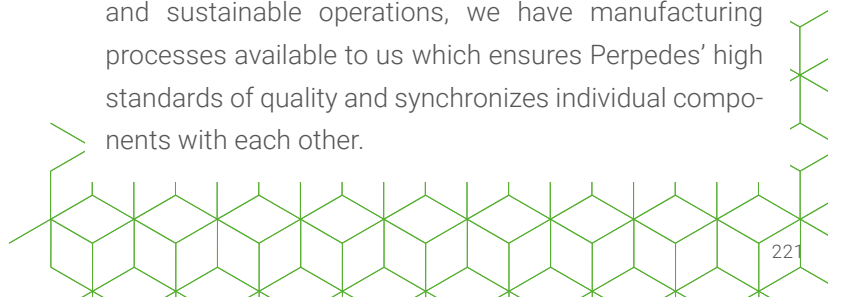

# KNITTED GLASS FIBER

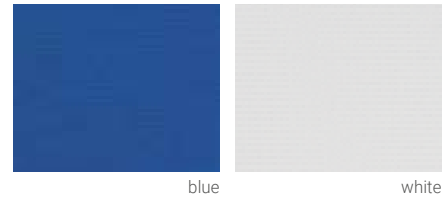

## MATERIAL COMPOSITION

Knitted glass fiber with acrylic matrix

## CHARACTERISTICS

- Very good plasticity
- Average stiffness
- Thermalplastic processing at 130°-140°C

## DELIVERY FORM

Available as sheet  
Available as ACRYLIC foot orthotic shell

ITEM NO.	DESCRIPTION	COLOR	LAYERS	RESILIENCE	SIZE RANGE	THICKNESS
70G42130	G421	blue	2	bidirectional	50 x 120 cm	1.0 - 1.3 mm
70G421	G421	white	2	bidirectional	50 x 120 cm	1.0 - 1.3 mm
70G421+	G421+	white	2	bidirectional	50 x 120 cm	1.0 - 1.6 mm
70G43130	G431	blue	4	bidirectional	50 x 120 cm	1.4 - 1.8 mm
70G431	G431	white	4	bidirectional	50 x 120 cm	1.4 - 1.8 mm

# KNITTED GLASS FIBER/KNITTED POLYAMIDE

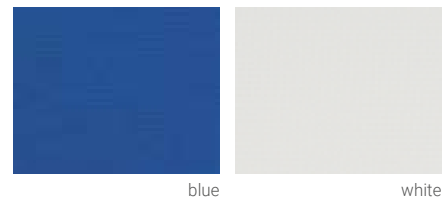

## MATERIAL COMPOSITION

Knitted glass fiber / knitted polyamide with acrylic matrix

## CHARACTERISTICS

- With embedded stitch yarns
- Very good plasticity
- High stiffness
- Thermalplastic processing at 130°-140°C

## DELIVERY FORM

- Available as sheet
- Available as ACRYLIC foot orthotic shell

ITEM NO.	DESCRIPTION	COLOR	LAYERS	RESILIENCE	SIZE RANGE	THICKNESS
70G42230	G422	blue	5	bidirectional	50 x 120 cm	2.2 - 2.5 mm
70G422	G422	white	5	bidirectional	50 x 120 cm	2.2 - 2.5 mm
70G422+	G422+	blue	5	bidirectional	50 x 120 cm	2.5 - 2.8 mm
70G422+30	G422+	white	5	bidirectional	50 x 120 cm	2.5 - 2.8 mm
70GPH441	GPH441	white	3	bidirectional	50 x 120 cm	1.4 - 1.7 mm
70GPH44130	GPH441	blue	3	bidirectional	50 x 120 cm	1.4 - 1.7 mm
70GPH451	GPH451	white	4	bidirectional	50 x 120 cm	1.6 - 2.0 mm
70GPH45130	GPH451	blue	4	bidirectional	50 x 120 cm	1.6 - 2.0 mm

# KNITTED GLASS FIBER/KNITTED POLYAMIDE

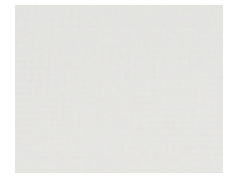

white

## MATERIAL COMPOSITION

Knitted glass fiber / knitted polyamide with acrylic matrix

## DELIVERY FORM

- Available as sheet
- Available as ACRYLIC foot orthotic shell

## CHARACTERISTICS

- Good plasticity
- Average stiffness
- Thermalplastic processing at 130°-140°C

ITEM NO.	DESCRIPTION	COLOR	LAYERS	RESILIENCE	SIZE RANGE	THICKNESS
70GH501	GH501	white	6	bidirectional	50 x 120 cm	2.2 - 2.5 mm
70GH502	GH502	white	8	bidirectional	50 x 120 cm	2.7 - 3.3 mm
70GH503	GH503	white	10	bidirectional	50 x 120 cm	3.2 - 3.8 mm

# WOVEN GLASS FIBER/KNITTED POLYAMIDE

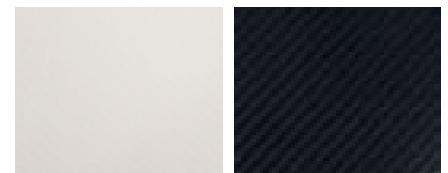

white

black

## MATERIAL COMPOSITION

Woven glass fiber / knitted polyamide with acrylic matrix

## DELIVERY FORM

- Available as sheet
- Available as ACRYLIC foot orthotic shell

## CHARACTERISTICS

- Very good plasticity
- High stiffness
- Thermalplastic processing at 130°-140°C

ITEM NO.	DESCRIPTION	COLOR	LAYERS	RESILIENCE	SIZE RANGE	THICKNESS
70GH70181	GH701	white	3	bidirectional	50 x 120 cm	1.0 - 1.2 mm
70GH70281	GH702	white	4	bidirectional	50 x 120 cm	1.4 - 1.8 mm
70GH70381	GH703	white	4	bidirectional	50 x 120 cm	1.6 - 2.0 mm
70BF7001	BF7001	black	3	bidirectional	50 x 120 cm	1.0 - 1.2 mm
70BF7002	BF7002	black	4	bidirectional	50 x 120 cm	1.4 - 1.8 mm
70BF7003	BF7003	black	5	bidirectional	50 x 120 cm	1.6 - 2.0 mm

# KNITTED CARBON FIBER

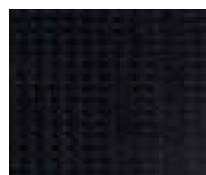

black

## MATERIAL COMPOSITION

Knitted carbon fiber with acrylic matrix

## CHARACTERISTICS

- Excellent plasticity
- Average stiffness
- Thermalplastic processing at 130°-140°C

## DELIVERY FORM

- Available as sheet
- Available as ACRYLIC foot orthotic shell

ITEM NO.	DESCRIPTION	COLOR	LAYERS	RESILIENCE	SIZE RANGE	THICKNESS
70C601	C601	black	4	bidirectional	40 x 120 cm	1.0 - 1.3 mm
70C602	C602	black	8	bidirectional	40 x 120 cm	2.0 - 2.3 mm
70C603	C603	black	12	bidirectional	40 x 120 cm	2.6 - 3.1 mm

# KNITTED CARBON FIBER/KNITTED POLYAMIDE



black

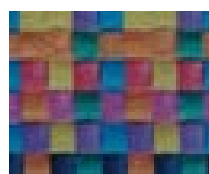

decor



blue

## MATERIAL COMPOSITION

Knitted carbon fiber / knitted polyamide with acrylic matrix

## CHARACTERISTICS

- Excellent plasticity
- Average stiffness
- Thermalplastic processing at 130°-140°C

## DELIVERY FORM

- Available as sheet
- Available as ACRYLIC foot orthotic shell

ITEM NO.	DESCRIPTION	COLOR	LAYERS	RESILIENCE	SIZE RANGE	THICKNESS
70C501	C501	black	8	bidirectional	40 x 120 cm	1.3 - 1.7 mm
70C502	C502	black	10	bidirectional	40 x 120 cm	2.0 - 2.3 mm
70C511RB	C511	decor	5	bidirectional	40 x 120 cm	1.8 - 2.0 mm
70C521RB	C521	decor/decor	6	bidirectional	40 x 120 cm	2.0 - 2.3 mm
70C522RB	C522	decor/decor	6	bidirectional	40 x 120 cm	2.0 - 2.6 mm
70C101	C101	blue	6	bidirectional	40 x 120 cm	1.6 - 2.1 mm
70C102	C102	blue	8	bidirectional	40 x 120 cm	2.5 - 3.2 mm

# WOVEN CARBON FIBER/KNITTED POLYAMIDE

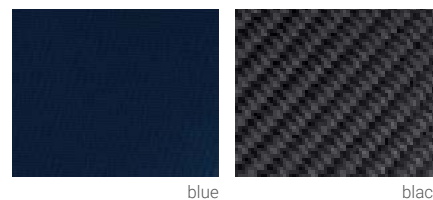

## MATERIAL COMPOSITION

Woven carbon fiber / knitted polyamide with acrylic matrix

## DELIVERY FORM

- Available as sheet
- Available as ACRYLIC foot orthotic shell

## CHARACTERISTICS

- Good plasticity
- Very high stiffness
- Thermalplastic processing at 130°-140°C

ITEM NO.	DESCRIPTION	COLOR	LAYERS	RESILIENCE	SIZE RANGE	THICKNESS
70C201	C201	blue	3	bidirectional	50 x 120 cm	1.0 - 1.3 mm
70C202	C202	blue	3	bidirectional	50 x 120 cm	1.5 - 1.8 mm
70C203	C203	blue	6	bidirectional	50 x 120 cm	2.8 - 3.2 mm
70C205	C205	blue	6	bidirectional	50 x 120 cm	3.4 - 3.8 mm
70C206	C206	black	3	bidirectional	50 x 120 cm	1.9 - 2.3 mm
70KE8A5	C206V	black	4	bidirectional	50 x 120 cm	2.1 - 2.5 mm
70KD8A5	C226	black	4	bidirectional	50 x 120 cm	2.3 - 2.7 mm
70KC8A5	C812	black	3	bidirectional	47 x 120 cm	1.0 - 1.4 mm

# CARBON FIBER/POLYAMIDE MIX



## MATERIAL COMPOSITION

Knitted and woven Carbon fiber / knitted polyamide with acrylic matrix

## DELIVERY FORM

- Available as sheet
- Available as ACRYLIC foot orthotic shell

## CHARACTERISTICS

- Good plasticity
- High stiffness
- Thermalplastic processing at 130°-140°C

ITEM NO.	DESCRIPTION	COLOR	LAYERS	RESILIENCE	SIZE RANGE	THICKNESS
70C301	C301	blue	9	bidirectional	40 x 100 cm	2.6 - 3.0 mm
70C302	C302	blue	7	bidirectional	40 x 100 cm	2.8 - 3.3 mm

Perpedes 4YOU  
 Self-supporting foot orthoses  
 Accomodative foot-orthoses  
 Heel cupped foot orthoses  
 Sensomotoric foot orthoses  
 Self-supporting orthotic shells  
 Shoe / insole stiffeners  
 Top covers  
 Cushion materials  
 Top layers combinations  
 Base / bottom covers  
 Acrylic fiber composite sheets  
 Balancer / met pads  
 Cushion and pads  
 Assessment  
 Good to know





# ACCESSORIES



# BALANCER

# BALANCER - HEEL POST MODULE

The BALANCER is the perfect solution to quickly add a heel post or platform to a foot orthotic. After glueing to the orthotic's shell it needs to be ground down evenly, both medially and laterally for a neutral post. To simplify this, indicators were laterally and medially cut into the BALANCER. The upper edge of the bottom indicator marks a reduction of 2 mm and the

upper edge of the upper indicator marks a reduction of 4 mm. The BALANCER can further be used to compensate leg length discrepancies. Eversion or inversion posts affect the position of the heel which helps to re-align pathological postures of the foot / ankle / knee / hip joints. The BALANCER's medial and lateral indicators help achieving a precise correction.



## PRODUCT FACTS

Size range: (35) 36 - 47 (48)  
 Weight: 20g / unit  
 Material: Thermoplastic polyurethane (TPU)

## THE BALANCER IS RECOMMENDED TO BE USED WITH THE FOLLOWING PERPEDES FOOT ORTHOTICS:

DAILY<sup>2</sup> LINE (except DAILY<sup>2</sup> CONTROL)  
 PERFECT FIT LINE  
 SOLEUTION LINE

CALCA LINE  
 ACRYLIC LINE (101, 101DET, 113, 115, 116)

## BALANCER - HEEL POST MODULE

ITEM NO.	DESCRIPTION	SIZE RANGE	SELLING UNIT
SH60	BALANCER - HEEL POST MODULE	36 - 38*	10 / 50 pairs
SH61	BALANCER - HEEL POST MODULE	39 - 41	10 / 50 pairs
SH62	BALANCER - HEEL POST MODULE	42 - 44	10 / 50 pairs
SH63	BALANCER - HEEL POST MODULE	45 - 47**	10 / 50 pairs

\* applicable from size 35 \*\* applicable also up to size 48

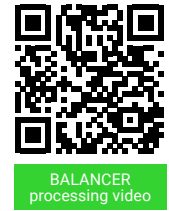

BALANCER  
processing video

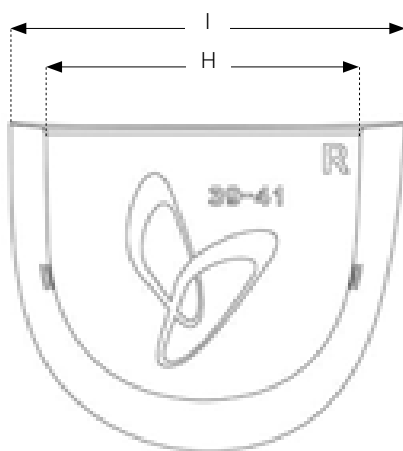
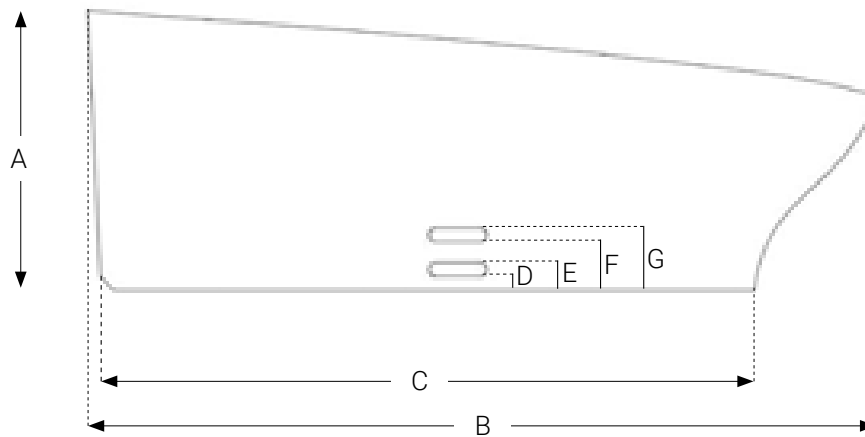

### DIMENSIONS

in mm	SH60	SH61	SH62	SH63
A Height of BALANCER	20	20	20	20
B Length of BALANCER	53	57	61	65
C Length of base	43	47	51	55
D Lower mark at bottom	1	1	1	1
E Lower mark at top	2	2	2	2
F Upper mark at bottom	3	3	3	3
G Upper mark at top	4	4	4	4
H Width of base	51	54	57	60
I Width of BALANCER	64	68	72	76

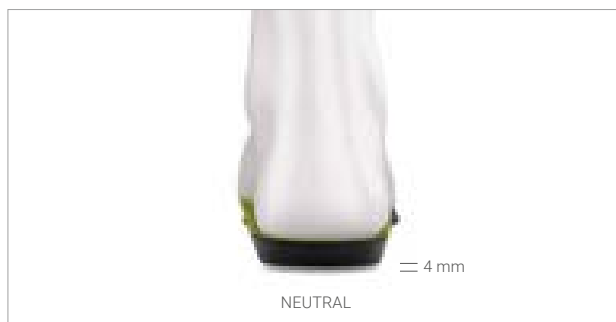

### NEUTRAL POSTING, DIFFERENCE IN LEG LENGTH, AFFLICTIONS OF THE ACHILLES TENDON:

The BALANCER is the perfect solution to quickly create a neutral post and platform for the heel. It needs to be ground down evenly, both medially and laterally. The BALANCER can further be adjusted to compensate a difference in leg length of max. 4 mm. Thicker heel lifts can be built up with dense EVA material onto the BALANCER's sanded and even platform.

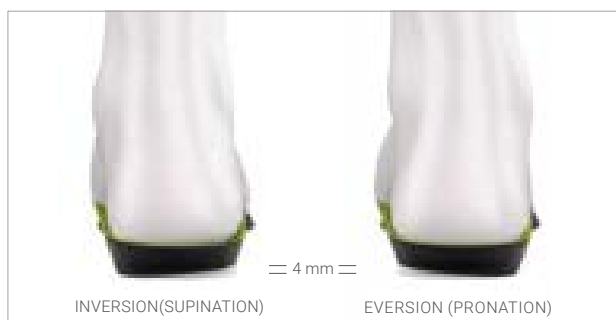

### EVERSION / INVERSION POSTING, VARUS / VALGUS DEFORMITIES OF THE HEEL, DEFORMITIES (ARTHROSIS) OF THE ANKLE, KNEE AND HIP JOINTS:

With the help of the BALANCER, the position of the heel is realigned so that possible malpostures of foot / ankle / knee / hip joints can be positively affected. For this purpose, the BALANCER must be ground down either medially or laterally on one side more than on the other (depending on the required result). The medial and lateral indicators in the material help achieving this. See table „DIMENSIONS“ for details.



# MET PADS

# METATARSAL PADS

## DROP SHAPE

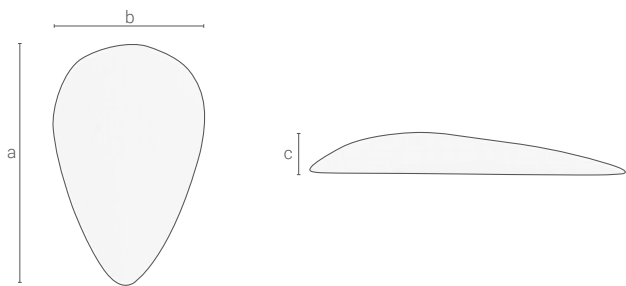

2026 made of Carbosan foam

ITEM NO.	SIZE RANGE	LENGTH (a)	WIDTH (b)	HEIGHT (c)
P202613_	13	70 mm	39 mm	10 mm

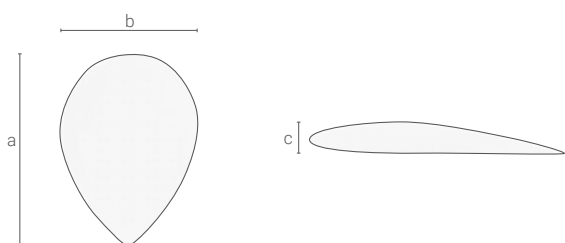

2030 made of Carbosan foam

ITEM NO.	SIZE RANGE	LENGTH (a)	WIDTH (b)	HEIGHT (c)
P2030_	0	55 mm	40 mm	6 mm

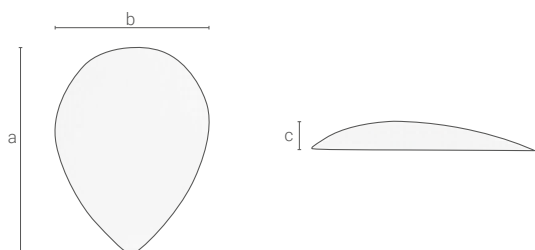

2031 made of Carbosan foam

ITEM NO.	SIZE RANGE	LENGTH (a)	WIDTH (b)	HEIGHT (c)
P20311_	1	42 mm	31 mm	6 mm
P20312_	2	48 mm	36 mm	6 mm
P20313_	3	55 mm	40 mm	6 mm

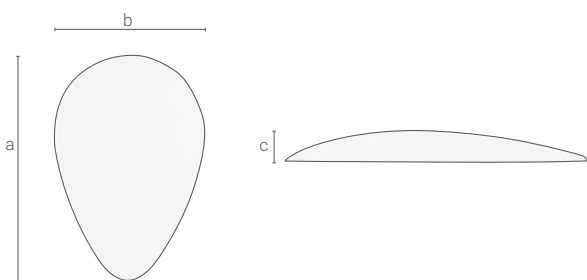

2032 made of Carbosan foam

ITEM NO.	SIZE RANGE	LENGTH (a)	WIDTH (b)	HEIGHT (c)
P20321_	1	61 mm	40 mm	7 mm
P20322_	2	66 mm	44 mm	8 mm

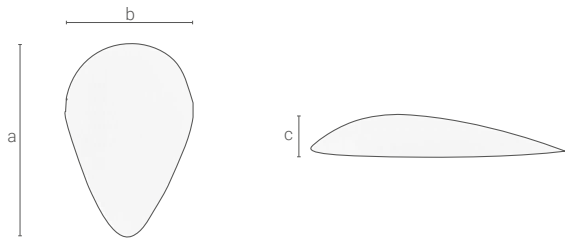

2057 made of Carbosan foam

ITEM NO.	SIZE RANGE	LENGTH (a)	WIDTH (b)	HEIGHT (c)
P20571_	1	50 mm	32 mm	8 mm
P20572_	2	57 mm	37 mm	10 mm
P20573_	3	60 mm	40 mm	12 mm

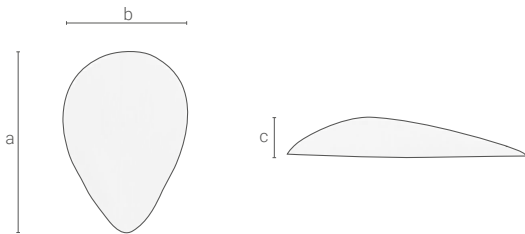

2065 made of Carbosan foam

ITEM NO.	SIZE RANGE	LENGTH (a)	WIDTH (b)	HEIGHT (c)
P20651_	1	52 mm	36 mm	10 mm

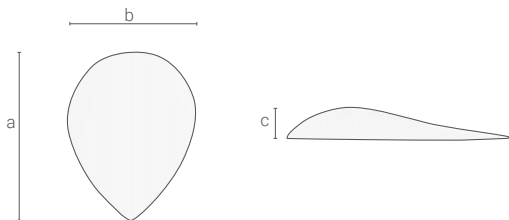

21388 made of Carbosan foam

ITEM NO.	SIZE RANGE	LENGTH (a)	WIDTH (b)	HEIGHT (c)
P21388H_	H	51 mm	36 mm	7 mm
P21388C_	C	57 mm	41 mm	6 mm
P21605F_	F	67 mm	45 mm	6 mm

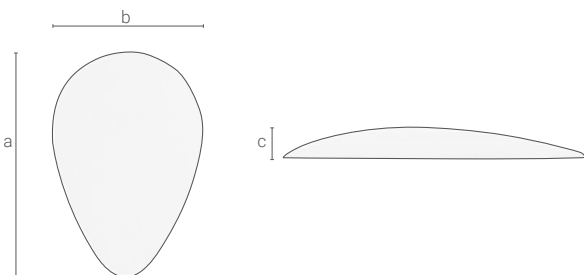

3425 made of Carbosan foam

ITEM NO.	SIZE RANGE	LENGTH (a)	WIDTH (b)	HEIGHT (c)
P34251_	1	53 mm	40 mm	6 mm
P34252_	2	54 mm	41 mm	6 mm
P34253_	3	57 mm	43 mm	6 mm

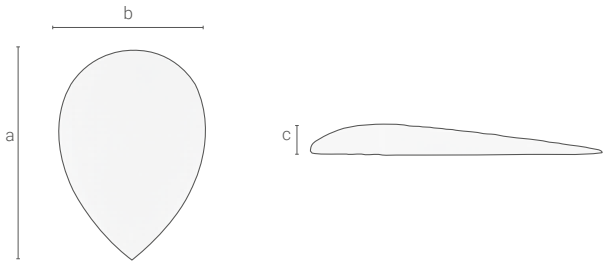

ITEM NO.	SIZE RANGE	LENGTH (a)	WIDTH (b)	HEIGHT (c)
P3441_	1	55 mm	40 mm	3 mm
P3442_	2	60 mm	42 mm	4 mm

3441 made of Carbosan foam

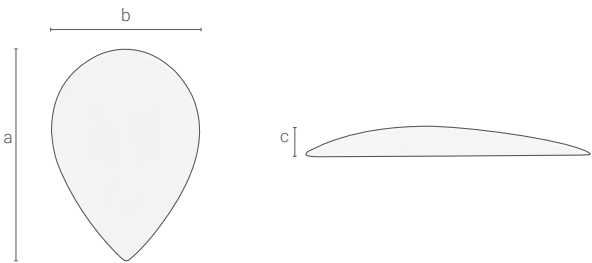

ITEM NO.	SIZE RANGE	LENGTH (a)	WIDTH (b)	HEIGHT (c)
P39171_	1	57 mm	38 mm	5 mm
P39172_	2	60 mm	43 mm	7 mm
P39173_	3	62 mm	45 mm	8 mm

3917 made of Carbosan foam

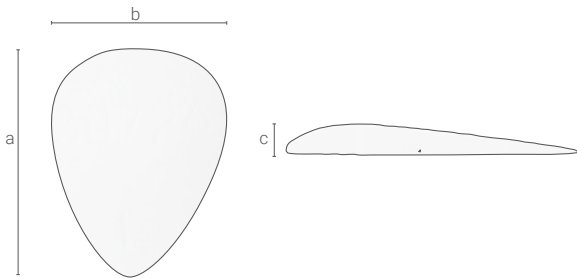

ITEM NO.	SIZE RANGE	LENGTH (a)	WIDTH (b)	HEIGHT (c)
P30726_	1	45 mm	39 mm	5 mm

30726 made of Carbosan foam

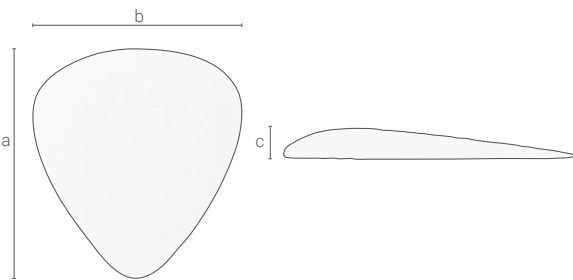

ITEM NO.	SIZE RANGE	LENGTH (a)	WIDTH (b)	HEIGHT (c)
P308151_	1	37 mm	36 mm	4 mm
P308152_	2	43 mm	38 mm	4 mm
P308153_	3	48 mm	50 mm	4 mm

30815 made of Carbosan foam

## ANATOMIC SHAPE

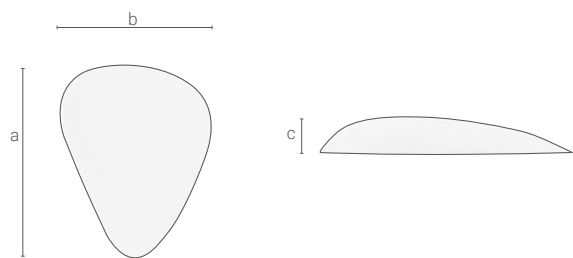

2041 made of Carbosan foam

ITEM NO.	SIZE RANGE	LENGTH (a)	WIDTH (b)	HEIGHT (c)
P20411_	1	53 mm	39 mm	8 mm
P20412_	2	55 mm	44 mm	9 mm

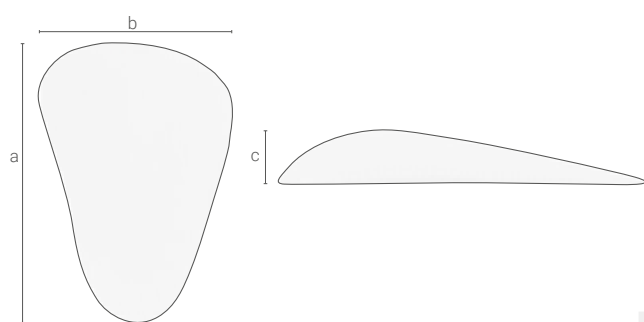

2027 made of Carbosan foam

ITEM NO.	SIZE RANGE	LENGTH (a)	WIDTH (b)	HEIGHT (c)
P202717_	17	80 mm	55 mm	12 mm

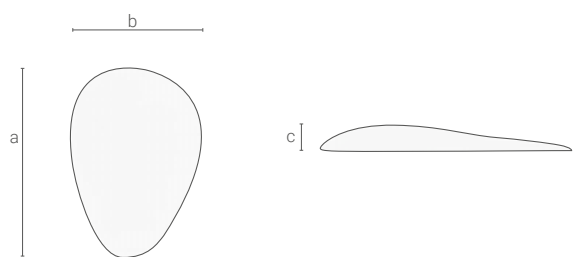

3415 made of Carbosan foam

ITEM NO.	SIZE RANGE	LENGTH (a)	WIDTH (b)	HEIGHT (c)
P34151_	1	52 mm	35 mm	5 mm
P34152_	2	58 mm	40 mm	6 mm
P34153_	3	65 mm	45 mm	7 mm
P34154_	4	70 mm	50 mm	8 mm

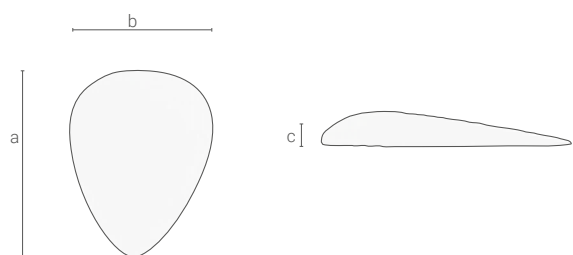

3425 made of Carbosan foam

ITEM NO.	SIZE RANGE	LENGTH (a)	WIDTH (b)	HEIGHT (c)
P342511_	1	54 mm	40 mm	6 mm
P342512_	2	55 mm	43 mm	7 mm
P342513_	3	56 mm	46 mm	8 mm

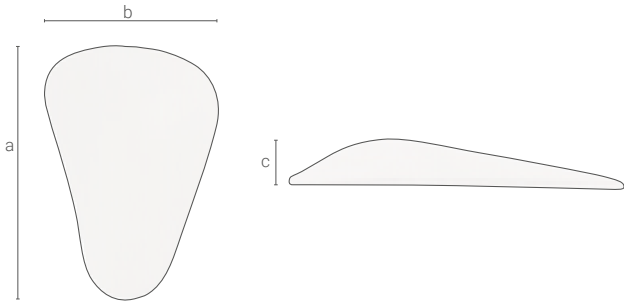

5767 made of sponge rubber

ITEM NO.	SIZE RANGE	LENGTH (a)	WIDTH (b)	HEIGHT (c)
P576711_	11	73 mm	50 mm	10 mm

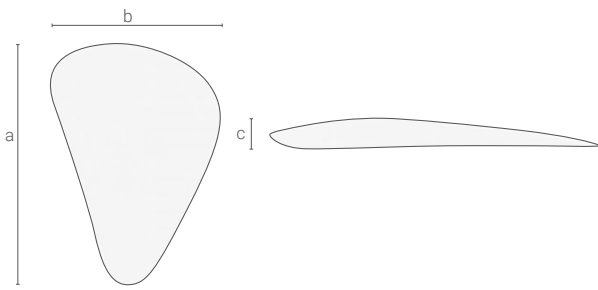

6648 made of Carbosan foam

ITEM NO.	SIZE RANGE	LENGTH (a)	WIDTH (b)	HEIGHT (c)
P66481_	1	63 mm	45 mm	7 mm
P66482_	2	70 mm	50 mm	7 mm
P66483_	3	76 mm	54 mm	8 mm

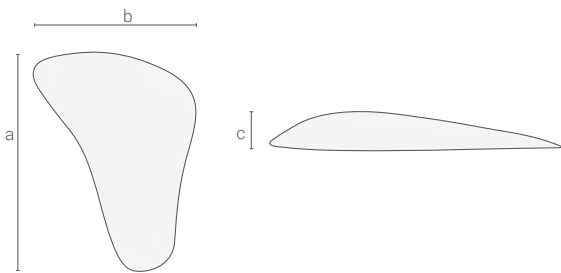

7443 made of Carbosan foam

ITEM NO.	SIZE RANGE	LENGTH (a)	WIDTH (b)	HEIGHT (c)
P74431_	1	65 mm	47 mm	8 mm
P74432_	2	68 mm	49 mm	11 mm
P74433_	3	75 mm	53 mm	12 mm
P74434_	4	83 mm	59 mm	13 mm

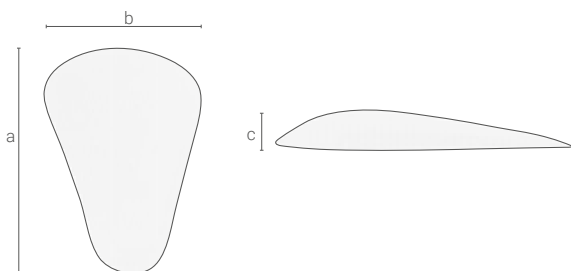

12436 made of Carbosan foam

ITEM NO.	SIZE RANGE	LENGTH (a)	WIDTH (b)	HEIGHT (c)
P1243610_	10	68 mm	45 mm	8 mm
P1243611_	11	74 mm	51 mm	8 mm
P1243612_	12	80 mm	59 mm	10 mm

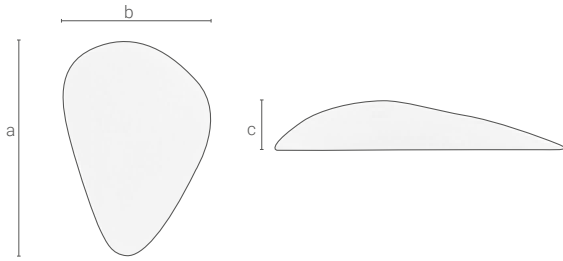

12971 made of Carbosan foam

ITEM NO.	SIZE RANGE	LENGTH (a)	WIDTH (b)	HEIGHT (c)
P129712_	2	60 mm	43 mm	12 mm

### RETROCAPITAL SHAPE

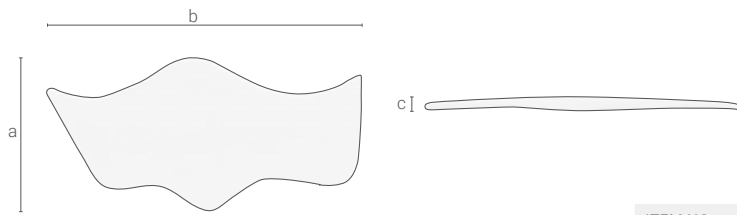

21422 made of Carbosan foam

ITEM NO.	SIZE RANGE	LENGTH (a)	WIDTH (b)	HEIGHT (c)
P214222_	2	58 mm	116 mm	7 mm

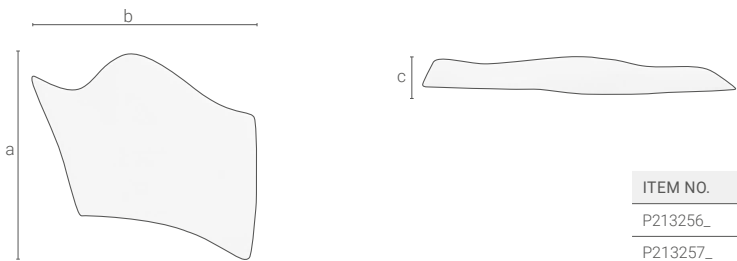

21325 made of Carbosan foam

ITEM NO.	SIZE RANGE	DESCRIPTION	LENGTH (a)	WIDTH (b)	HEIGHT (c)
P213256_	6	-	65 mm	87 mm	10 mm
P213257_	7	-	67 mm	92 mm	11 mm
P213258_	8	-	90 mm	94 mm	11 mm
P213259_	9	-	95 mm	105 mm	12 mm

# TONUSCONTROL

## TOE CREST

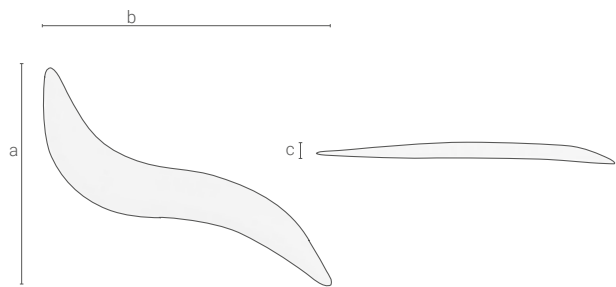

ITEM NO.	SIZE RANGE	LENGTH (a)	WIDTH (b)	HEIGHT (c)
P215283_	3	52 mm	12 mm	4 mm
P215284_	4	70 mm	13 mm	4 mm
P215285_	5	84 mm	18 mm	5 mm

21528 made of Carbosan foam

## TOE REST

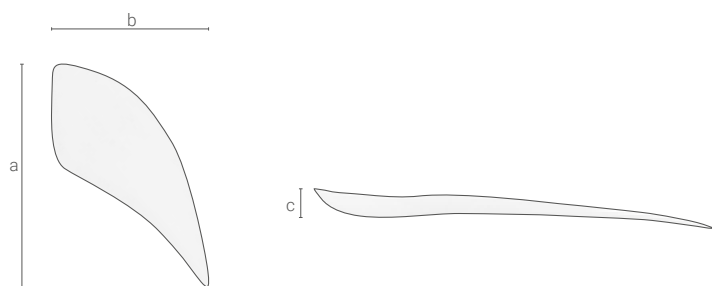

ITEM NO.	SIZE RANGE	LENGTH (a)	WIDTH (b)	HEIGHT (c)
P306694_	4	87 mm	61 mm	6 mm
P306695_	5	93 mm	62 mm	7 mm
P306696_	6	115 mm	65 mm	9 mm

30669 made of Carbosan foam

## MPT 1 PAD

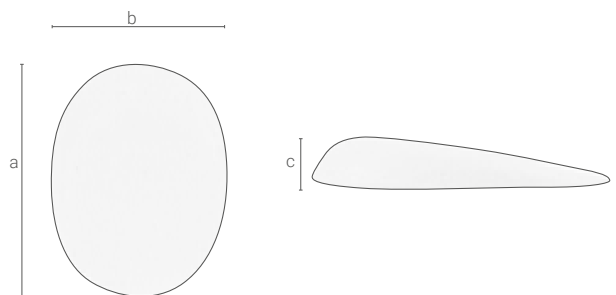

ITEM NO.	SIZE RANGE	LENGTH (a)	WIDTH (b)	HEIGHT (c)
P2153100_	00	23 mm	19 mm	4 mm
P215310_	0	25 mm	20 mm	4 mm
P215311_	1	29 mm	22 mm	5 mm
P215312_	2	33 mm	25 mm	5 mm
P215313_	3	40 mm	30 mm	7 mm

21531 made of Carbosan foam

## METATARSAL PAD, ACTIVE

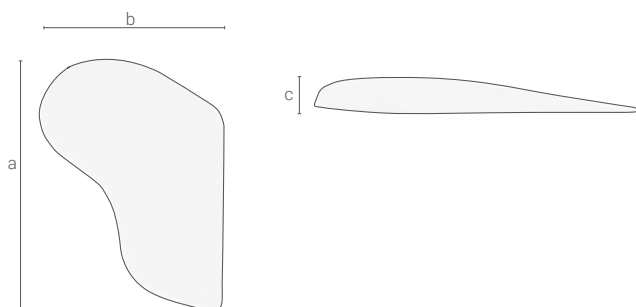

21529 made of Carbosan foam

ITEM NO.	SIZE RANGE	LENGTH (a)	WIDTH (b)	HEIGHT (c)
P215291_	1	62 mm	49 mm	4 mm
P215292_	2	75 mm	55 mm	6 mm
P215293_	3	80 mm	61 mm	7 mm
P215294_	4	94 mm	67 mm	7 mm
P215295_	5	105 mm	72 mm	7 mm

## METATARSAL PAD, PASSIVE

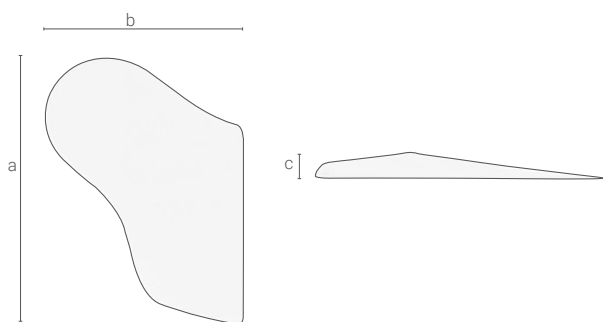

30668 made of Carbosan foam

ITEM NO.	SIZE RANGE	LENGTH (a)	WIDTH (b)	HEIGHT (c)
P306683_	3	84 mm	62 mm	6 mm
P306684_	4	95 mm	65 mm	6 mm
P306685_	5	106 mm	72 mm	7 mm

## HINDFOOT PAD

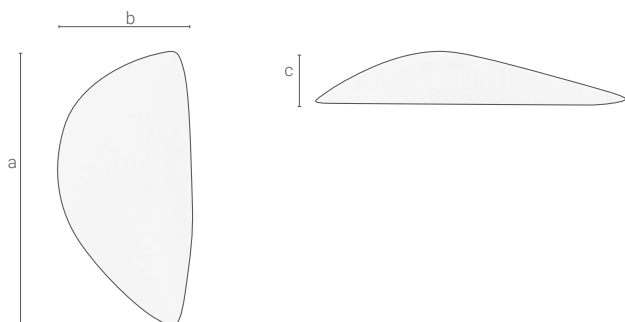

21530 made of Carbosan foam

ITEM NO.	SIZE RANGE	LENGTH (a)	WIDTH (b)	HEIGHT (c)
P215301_	1	35 mm	15 mm	7 mm
P215302_	2	37 mm	17 mm	8 mm
P215303_	3	43 mm	21 mm	9 mm
P215304_	4	48 mm	24 mm	9 mm
P215305_	5	53 mm	27 mm	10 mm
P215306_	6	60 mm	27 mm	11 mm
P215307_	7	72 mm	38 mm	12 mm



# CUSHIONS AND PADS

# PERPEDES COMFORT CUSHIONS

## HEEL CUSHIONS

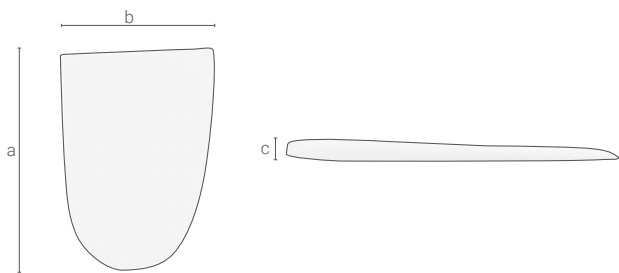

21282 made of Carbosan foam

ITEM NO.	SIZERANGE	DESCRIPTION	LENGTH (a)	WIDTH (b)	HEIGHT (c)
P2128237_	37	-	92 mm	65 mm	7 mm
P2128241_	41	-	102 mm	71 mm	7 mm
P2128243_	43	-	105 mm	77 mm	7 mm
P2128246_	46	-	107 mm	80 mm	7 mm

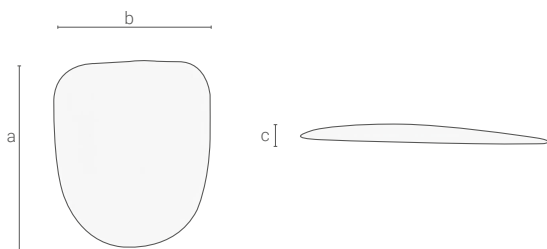

1001 made of Carbosan foam

ITEM NO.	SIZERANGE	DESCRIPTION	LENGTH (a)	WIDTH (b)	HEIGHT (c)
P1001_	-	-	55 mm	45 mm	4 mm

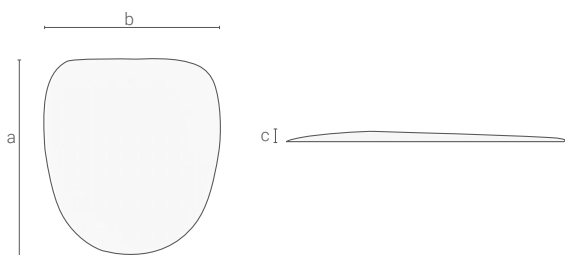

DAILY High Heel / 1014 made of Carbosan foam

ITEM NO.	SIZERANGE	DESCRIPTION	LENGTH (a)	WIDTH (b)	HEIGHT (c)
P1014_	-	-	65 mm	56 mm	4 mm

## COMFORT CUSHIONS

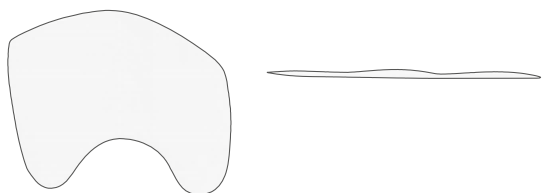

**DAILY HIGH HEEL Comfort forefoot cushion**  
made of Carbosan foam

ITEM NO.	SHOE SIZE RANGE	DESCRIPTION
P30898_	36/37 - 42/43	DAILY HIGH HEEL Comfort forefoot cushion made of Carbosan foam

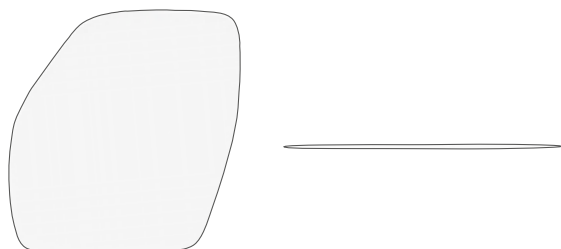

**UNIVERSAL COMFORT FOREFOOT CUSHION**  
made of Carbosan foam

ITEM NO.	SHOE SIZE RANGE	DESCRIPTION
P38081_	35 - 39	COMFORT forefoot cushion
P38082_	40 - 42	COMFORT forefoot cushion
P38083_	43 - 46	COMFORT forefoot cushion
P38084_	47 - 52	COMFORT forefoot cushion

BUSINESS SQAURE NATURE

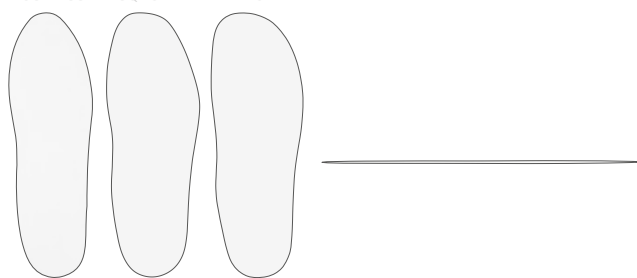

**DAILY Comfort cushion** made of Carbosan foam

ITEM NO. OLD	ITEM NO. NEW	SHOE SIZE RANGE	DESCRIPTION
P30806_	-	35 - 52	DAILY COMFORT cushion made of Carbosan foam, BUSINESS
P30807_	P30981_	35 - 52	DAILY COMFORT cushion made of Carbosan foam, NATURE
P30808_	P30980_	35 - 52	DAILY COMFORT cushion made of Carbosan foam, SQAURE

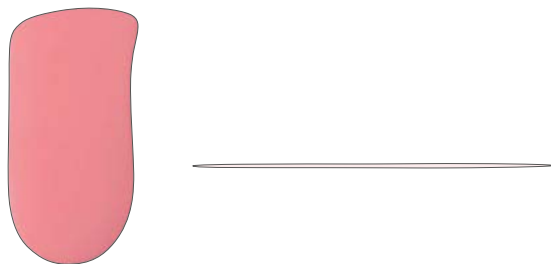

**CALCA PRO X CONTROL Comfort hindfoot cushion**  
made of PUR-Slow-Memory foam, red

ITEM NO.	SHOE SIZE RANGE	DESCRIPTION
P202670_	35 - 49	CALCA PRO X CONTROL COMFORT hindfoot cushion made of PUR-Slow-Memory-foam, red

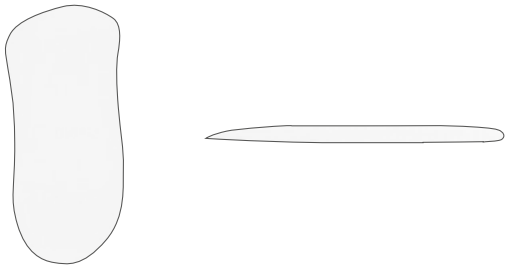

KID CONTROL COMFORT CUSHION made of Carbosan foam

ITEM NO.	SHOE SIZE RANGE	DESCRIPTION
P30903_	23/24 - 35/36	KID CONTROL COMFORT CUSHION made of Carbosan foam

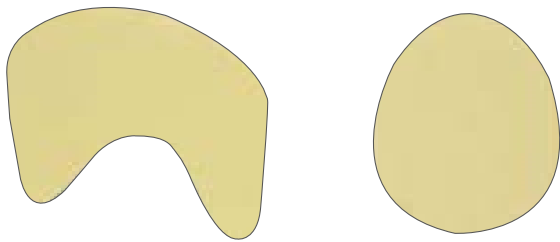

DAILY COMFORT+ CUSHION SET made of Shock Absorber X yellow, 7° Shore A

ITEM NO.	SHOE SIZE RANGE	DESCRIPTION
SF54_	35 - 52	DAILY COMFORT+ CUSHION SET made of Shock Absorber X yellow, 7° Shore A

# SILICON HEEL PAD

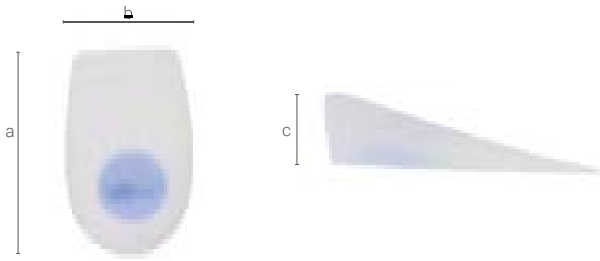

Silicone heel pad / 440

ITEM NO.	SIZE RANGE	DESCRIPTION	LENGTH (a)	WIDTH (b)	HEIGHT(c)
P440S_	S	-	90 mm	55 mm	7 mm
P440M_	M	-	110 mm	69 mm	8 mm
P440L_	L	-	120 mm	75 mm	9 mm



# ASSESSMENT

# ASSESSMENT

## PERPEDES FOOT IMPRESSION FOAM



ITEM NO.	DESCRIPTION	THICKNESS	SELLING UNIT
SH19	PERPEDES FOOT IMPRESSION FOAM, medical, in Perpedes design box	38 mm	50 pieces*

Perpedes medical foot impression foam (38 mm), Perpedes design box

\* Minimum quantity are 3 packaging units (=150 foam boxes). Discount for orders of 6 units or more. Surcharge for smaller orders apply.



ITEM NO.	DESCRIPTION	THICKNESS	SELLING UNIT
SH17	PERPEDES FOOT IMPRESSION FOAM, medical	58 mm	25 pieces

Perpedes medical foot impression foam (58 mm)

## PODOPAPER



ITEM NO.	SIZE RANGE	SELLING UNIT
SH30	-	100 sheets

2D imprint technique (carbon paper)

## PELOPRINT FILM



ITEM NO.	SIZE RANGE	SELLING UNIT
PE42	26-33	25 pieces

2D imprint technique (wax)

Cushion and pads

Balancer / met pads

Acrylic fiber composite sheets

Base / bottom covers

Top layers combinations

Cushion materials

Top covers

Shoe / insole stiffeners

Self-supporting orthotic shells

Sensomotoric foot orthoses

Heel cupped foot orthoses

Accommodative foot orthoses

Self-supporting foot orthoses

Perpedes 4YOU





# GOOD TO KNOW

Assessment

Cushion and pads

Balancer / met pads

Acrylic fiber composite sheets

Base / bottom covers

Top layers combinations

Cushion materials

Top covers

Shoe / insole stiffeners

Self-supporting orthotic shells

Sensomotoric foot orthoses

Heel cupped foot orthoses

Accommodative foot orthoses

Self-supporting foot orthoses

Perpedes 4YOU

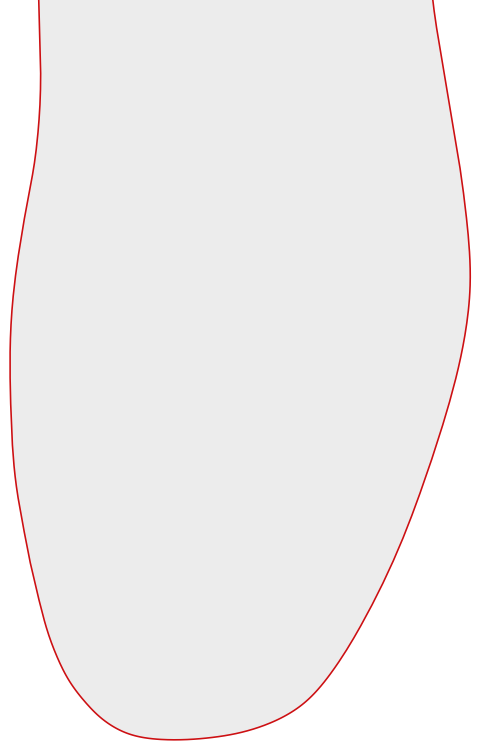

### SQUARE

Hint: Pronounced, wider forefoot outline

## OUTLINES

### VARIO

Hint: Suitable for casual footwear

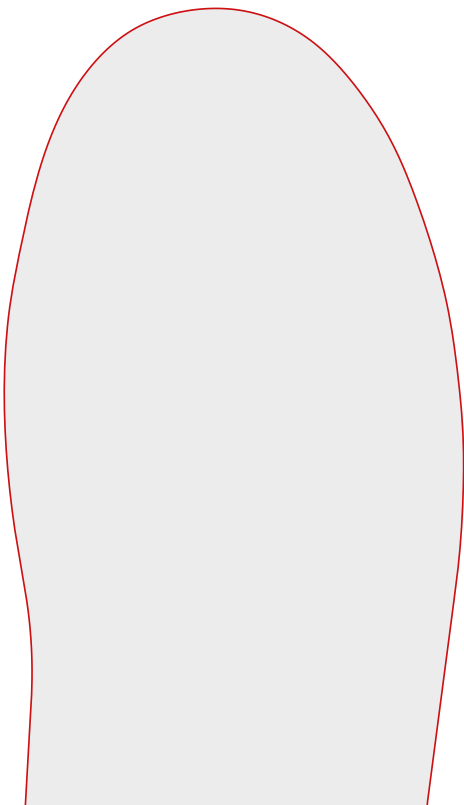

### BUSINESS

Hint: Suitable for business footwear

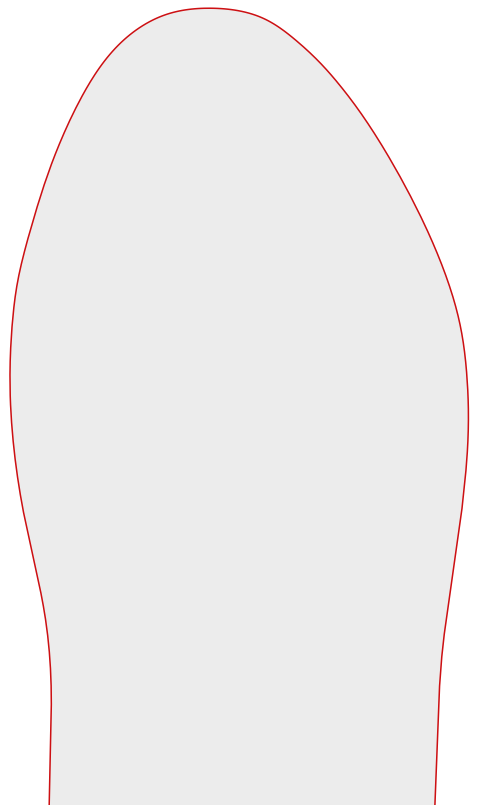

## COMFORT

Hint: Suitable for comfort shoes



Perpedes  
4YOU

Self-supporting  
foot orthoses

Accommodative  
foot orthoses

Heel cupped  
foot orthoses

Hint: Suitable for comfort shoes

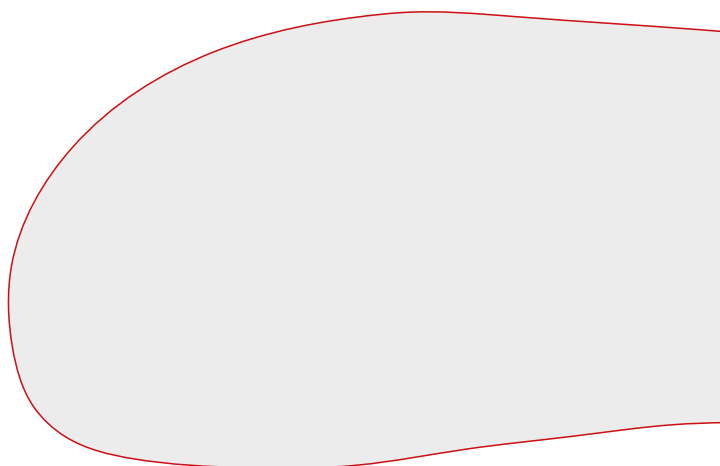

Sensomotoric  
foot orthoses

Self-supporting  
orthotic shells

Shoe / insole  
stiffeners

Top covers

Hint: Suitable for comfort shoes



Cushion  
materials

Top layers  
combinations

Base / bottom  
covers

Acrylic  
fiber composite  
sheets

## RECTANGLE

- Outline:
- 272 Size 1 (24 - 31)
  - 273 Size 2 (32 - 38)
  - 274 Size 3 (39 - 44)
  - 275 Size 4 (45 - 48)
  - 276 Size 5 (49 - 52)
  - 272XL Size 1: 10 x 24 cm (24 - 31)
  - 273XL Size 2: 12 x 28 cm (32 - 38)
  - 274XL Size 3: 14 x 31 cm (39 - 44)
  - 275XL Size 4: 16 x 34 cm (45 - 48)
  - 276XL Size 5: 18 x 37 cm (49 - 52)

Hint: Universally applicable

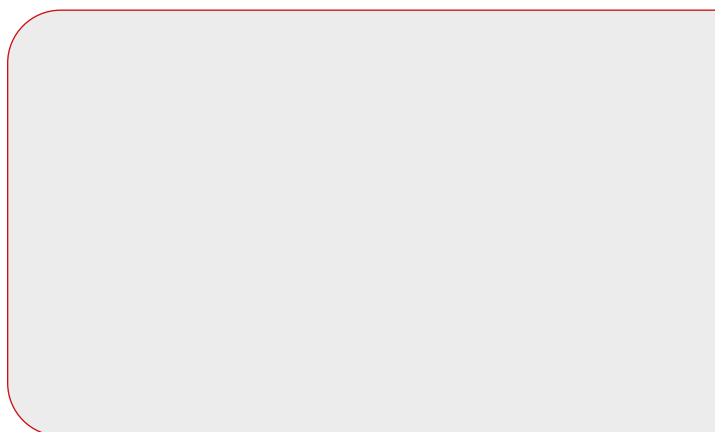

Balancer /  
met pads

Cushion  
and pads

Assessment

# LONGITUDINAL ARCH / 3D-CONTOUR

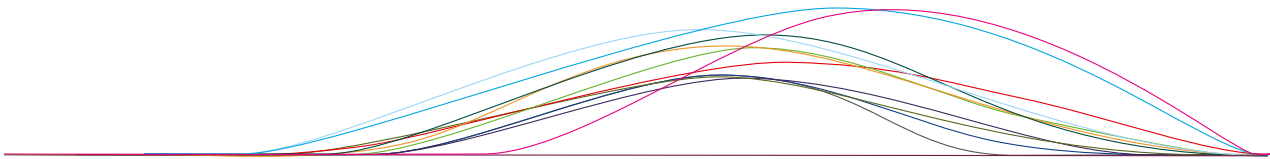

- F = flat
- SH = higher longitudinal arch support with guided heel
- R = higher longitudinal arch support with guided heel
- SM = low longitudinal arch support
- N = moderate longitudinal arch support with slightly guided heel
- TC = low longitudinal arch support with slightly guided heel
- PX = moderate longitudinal arch support with plantar fascia groove in the shell
- PXC = moderate longitudinal arch support with plantar fascia groove in the shell and guided heel
- DH = moderate longitudinal arch support with flat heel
- Z = longitudinal arch support for higher heel springs with flat heel
- DC = moderate longitudinal arch support with slight heel cup
- DA = moderate longitudinal arch support with slightly guided heel

F = flat



SH = higher longitudinal arch support with guided heel



R = higher longitudinal arch support with guided heel

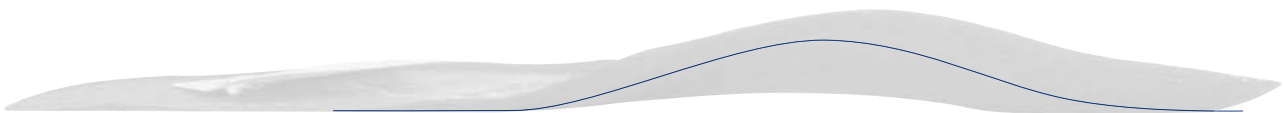

SM = low longitudinal arch support



N = moderate longitudinal arch support with slightly guided heel

Self-supporting  
foot orthoses

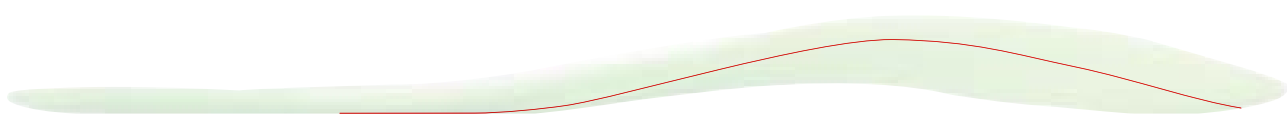

TC = low longitudinal arch support with slightly guided heel

Accommodative  
foot orthoses

Heel cupped  
foot orthoses

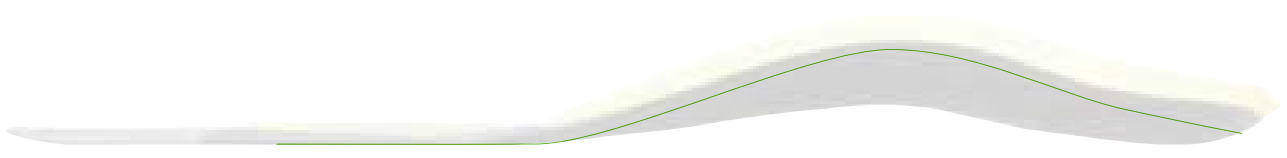

PX = moderate longitudinal arch support with plantar fascia groove in the shell

Sensomotoric  
foot orthoses

Self-supporting  
orthotic shells

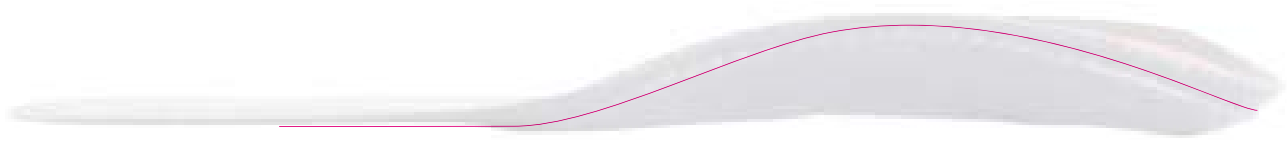

PXC = moderate longitudinal arch support with plantar fascia groove in the shell and guided heel

Shoe / insole  
stiffeners

Top covers

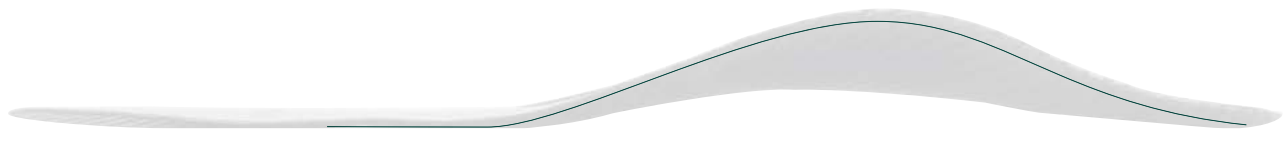

DH = moderate longitudinal arch support with flat heel

Cushion  
materials

Top layers  
combinations



Z = longitudinal arch support for higher heel springs with flat heel

Base / bottom  
covers

Acrylic  
fiber composite  
sheets

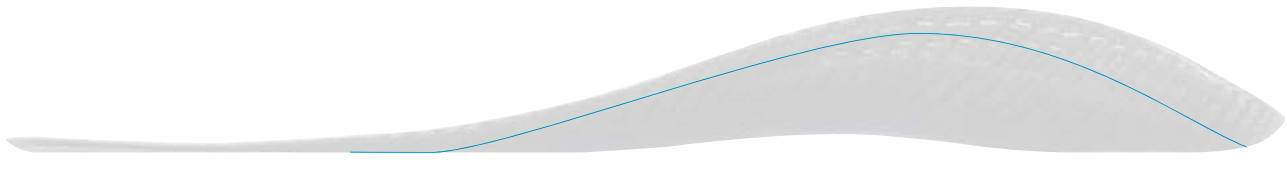

DC = moderate longitudinal arch support with slight heel cup

Balancer /  
met pads

Cushion  
and pads

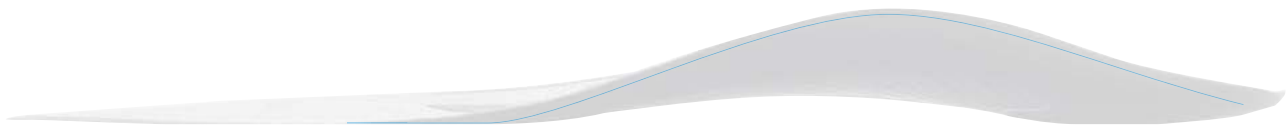











DA = moderate longitudinal arch support with slightly guided heel

Assessment

Good to know

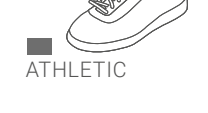
# PRODUCT SELECTION GUIDE

SYMPTOMS	CONDITIONS	PRODUCT RECOMMENDATION*		
<b>Arch pain</b> <b>Arch strain</b>	Overpronation	DAILY <sup>2</sup> (medium/narrow)		DAILY <sup>2</sup> (medium/narrow) ■ ■ ■ ■ ■
	Tarsal tunnel syndrome Achilles tendonitis Cuboid syndrome	DAILY <sup>2</sup> HIGH HEEL DAILY <sup>2</sup> CONTROL SOLEUTION SUPPORT		
<b>Heel pain</b>	Plantar fasciitis Calcaneus/Heel spur Pes cavus	CALCA PRO X CALCA PRO X CONTROL CALCA II		CPX CALCA PRO X CONTROL CALCA II ■ ■ ■ ■ ■
	Plantar calcaneal bursitis (Stone bruise) Calcaneal apophysitis (Sever's disease) Retro-calcaneal bursitis Haglund's deformity			
<b>Hallux limitus</b>	Morton's toe Pes cavus Sesamoiditis	SOLEUTION RIGIDUS		DAILY <sup>2</sup> CONTROL ■ ■ ■ ■ ■
<b>Forefoot pain</b>	Metatarsalgia Morton's neuroma Fat pad atrophy	DAILY <sup>2</sup> (medium/narrow) DAILY <sup>2</sup> HIGH HEEL SOLEUTION PAPILLON		DAILY <sup>2</sup> (medium/narrow) DAILY <sup>2</sup> CONTROL SOLEUTION PAPILLON CALCA PRO X CALCA II SOLEUTION PRO
<b>Bunions</b>	Hallux valgus	DAILY <sup>2</sup> (medium/narrow) DAILY <sup>2</sup> HIGH HEEL SOLEUTION PAPILLON		DAILY <sup>2</sup> (medium/narrow) DAILY <sup>2</sup> CONTROL SOLEUTION PAPILLON CALCA PRO X CALCA II SOLEUTION PRO
<b>Arthritis</b>	Gout Osteoarthritis (OA) Rheumatoid arthritis	DAILY <sup>2</sup> (medium/narrow) DAILY <sup>2</sup> CONTROL SOLEUTION PAPILLON CALCA PRO X CALCA II SOLEUTION PRO		SOLEUTION SUPPORT PRO RIGIDUS PAPILLON ■ ■ ■ ■ ■
<b>Flat feet</b> (with or without valgus heel)	Overpronation Flexible flat feet (non-rigid)	DAILY <sup>2</sup> (medium/narrow) DAILY <sup>2</sup> HIGH HEEL DAILY <sup>2</sup> CONTROL SOLEUTION SUPPORT SOLEUTION PRO		DAILY <sup>2</sup> (medium/narrow) DAILY <sup>2</sup> CONTROL SOLEUTION PAPILLON CALCA PRO X CALCA II SOLEUTION PRO
<b>Juvenile flat feet</b>	Overpronation Flexible flat feet (non-rigid)	KID CONTROL DAILY <sup>2</sup> CONTROL		KID CONTROL ■ ■ ■ ■ ■
<b>(Juvenile) Pes valgus</b>	Overpronation Pes valgus	KID CONTROL DAILY <sup>2</sup> CONTROL		DAILY <sup>2</sup> (medium/narrow) DAILY <sup>2</sup> HIGH HEEL DAILY <sup>2</sup> CONTROL SOLEUTION SUPPORT
<b>Lower leg pain</b>	Shin splints	DAILY <sup>2</sup> (medium/narrow) DAILY <sup>2</sup> HIGH HEEL DAILY <sup>2</sup> CONTROL SOLEUTION SUPPORT		DAILY <sup>2</sup> (medium/narrow) DAILY <sup>2</sup> HIGH HEEL SOLEUTION SUPPORT CALCA PRO X CALCA II
<b>Pregnancy</b> Arch pain	Metatarsalgia Overpronation	DAILY <sup>2</sup> (medium/narrow) DAILY <sup>2</sup> HIGH HEEL SOLEUTION SUPPORT		DAILY <sup>2</sup> HIGH HEEL ■ ■ ■ ■ ■
Heel pain	Plantar fasciitis	CALCA PRO X CALCA II		

\*depending on footwear



Product Selection will vary by activity level, age, weight and footwear type.  
This guide is not a substitute for the advice and guidance of a qualified medical professional.

# CONVERSION TABLE FOR EU/US/UK SIZES

EUROPE	UK	US WOMEN	US MEN
EU 35	UK 3	US 4 <sup>1/2</sup>	US 3 <sup>1/2</sup>
EU 36	UK 3 <sup>1/2</sup>	US 5 <sup>1/2</sup>	US 4 <sup>1/2</sup>
EU 37	UK 4 <sup>1/2</sup>	US 6	US 5
EU 38	UK 5	US 7	US 6
EU 39	UK 6	US 7 <sup>1/2</sup>	US 7
EU 40	UK 6 <sup>1/2</sup>	US 8 <sup>1/2</sup>	US 7 <sup>1/2</sup>
EU 41	UK 7 <sup>1/2</sup>	US 9 <sup>1/2</sup>	US 8 <sup>1/2</sup>
EU 42	UK 8	US 10	US 9
EU 43	UK 9	US 11	US 10
EU 44	UK 10	US 11 <sup>1/2</sup>	US 10 <sup>1/2</sup>
EU 45	UK 10 <sup>1/2</sup>	US 12 <sup>1/2</sup>	US 11 <sup>1/2</sup>
EU 46	UK 11 <sup>1/2</sup>	US 13	US 12
EU 47	UK 2	US 14	US 13
EU 48	UK 13	US 15	US 14
EU 49	UK 14	US 15 <sup>1/2</sup>	US 14 <sup>1/2</sup>
EU 50	UK 14 <sup>1/2</sup>	US 16 <sup>1/2</sup>	US 15 <sup>1/2</sup>
EU 51	UK 15		US 16
EU 52	UK 16		US 17

In case that a requested size is not covered in the chart, please order next half size up.

# TERMS OF SALE, DELIVERY AND PAYMENT

## 1. SCOPE

The below Terms of Sale, Delivery and Payment apply to all contracts, deliveries and other services between Perpedes GmbH and the Contract Partner, unless other agreements were made in writing. They are part of the business relationship and also apply to all future contracts, unless other agreements were made in writing in individual cases. Ancillary agreements require the written form to be effective.

The general terms and conditions of our Contract Partner only apply if we confirm them in writing.

## 2. OFFER; ORDERS

Presentation of products, deliveries and services of Perpedes GmbH on the internet and in brochures, leaflets or other information documents are subject to confirmation and non-binding. All information of a technical nature, illustrations and/or descriptions are mere service descriptions which do not represent a guarantee of specific features. The products, deliveries and services presented are an invitation for the Contract Partner to submit an offer to Perpedes GmbH for the conclusion of a contract based on their order/assignment.

The offer is deemed accepted as soon as either Perpedes GmbH confirms in writing to accept such offer or as soon as the ordered goods were shipped.

## 3. MANUFACTURER IN TERMS OF THE MDR; INLAY BLANK SUPPLIER

Since the purpose of the products has not yet been determined, an order for inlay blanks, materials and accessories represents no order for a medical device in terms of the MDR. Products have the status of a medical device only after further processing and after the customer determining the intended use. We make all reasonable efforts to support our customers who purchase inlay blanks, materials and accessories with regard to traceability and their obligation to documentation. When ordering therapeutic shoes, orthoses and individualised or specific orthopaedic inlays and other medical devices, the Contract Partner undertakes to comply with the obligations for dealers to which they are subject in accordance with Art. 14 of Regulation (EU) no. 2017/745 on medical devices. For further provisions under Regulation (EU) no. 2017/745 on medical devices, please refer to [www.perpedes.de](http://www.perpedes.de).

## 4. RIGHT OF WITHDRAWAL

A perfect credit standing of the Contract Partner is required for any and all deliveries. If, after contract conclusion, Perpedes GmbH becomes aware of circumstances which, at the discretion of the Perpedes GmbH, give reason to question the Contract Partner's credit standing regarding the contract amount, in particular due to a considerable deterioration of their financial situation, suspension of payments, clearance sale, business discontinuation, application for insolvency proceedings, foreclosure measures, cheque or bill protests, business dissolution, business transfer and similar circumstances, due to the Contract Partner pledging or providing to third parties as a security any inventories, receivables or purchased goods, them failing to pay outstanding invoices despite receiving reminders, admissible direct debit or standing orders not being redeemed or credit insurance of the Contract Partner being rejected and/or cancelled, Perpedes GmbH may demand advance payments or securities or withdraw from the contract. Contractual delivery periods are deemed to be interrupted from that date.

## 5. PRICES

Our sales prices are net prices in Euro. They are subject to changes and shall be deemed ex works prices, excluding VAT. All previous price lists and quotations become invalid once a new price list is published.

## 6. DELIVERY; SHIPPING INSURANCE

Delivery times we specified are approximate and non-binding; partial deliveries are permissible. All deliveries, including partial deliveries, are made at the Contract Partner's risk. This applies also to deliveries free of shipping charges. We are not liable for any damage or loss during transport. Each shipping order automatically includes insurance up to a value of € 520.00. In the case of higher goods values, the Contract Partner shall purchase additional insurance at their expense. Delivery delays or impediments we did not cause release us from a delivery obligation without the Contract Partner having a right to assert any rights or claims against us due to this.

## 7. SHIPPING

We ship the goods at our discretion by selecting the cheapest shipping method. The goods will be shipped at the Contract Partner's expense and risk, even if the latter does not bear the transport costs. According to the delivery times, incoming orders/assignments are divided into two groups: ready for shipping within 2 days (finished goods/stocked goods) and ready for shipping within more than 2 days (production orders). If the total order value exceeds € 500.00, we deliver free of packaging and shipping costs by commissioning DPD, a shipping company. Otherwise, the flat shipping fee for shipments within Germany is € 6.90 per order; for shipping costs to other countries, please refer to the offer. Shipping therapeutic shoes, resin canisters from sizes of 5 kg and foot impression foam boxes within Germany is always free of packaging and shipping costs.

For each order/assignment, only one packaging and shipping fee will be charged. The goods will be shipped at the Contract Partner's expense and risk, even if the latter does not bear the transport costs. The minimum net order value is € 50.00. For order values below this limit, a low quantity surcharge of € 5.00 will be invoiced.

## 8. DEVELOPED SAMPLES AND TRAINING DOCUMENTS; DESIGNS; DRAWINGS

We reserve the right of ownership and copyright to these documents and objects. They must not be copied or made available to third parties without our consent and shall be returned upon request.

## 9. SEMINARS

Cancellation at least 21 days before the beginning of the training course is free of charge. For cancellations at least 14 days prior to the beginning, we are forced to charge 33 % of the participation fee; 66 % thereof will be charged for cancellations at least 7 days before the training date. After that, a training fee refund is no longer possible. If the speaker is prevented from attending or if there are fewer participants than the minimum of 10 participants (4 participants for Soletec training courses), we reserve the right to cancel the event up to 10 days before the event day. In such cases, participants will be notified immediately and a paid entry fee will be refunded. Further claims are excluded.

## 10. TERMS OF PAYMENT

The general payment term applies: within 10 days: a 2 % discount; net invoice amount payable within 30 days from the invoice date. Small net amounts below € 50.00 are immediately payable. Our offers provide for the payment terms applicable to the foreign countries. Payments shall be made to Perpedes GmbH either in cash or by bank transfer. Timeliness of payment depends on the time when the amount is credited to the account of Perpedes GmbH. Bills of exchange will be accepted only if this was previously agreed. Discounts and bank charges shall be borne by the Contract Partner. We accept discount deductions only if all obligations from previous deliveries were fulfilled. In the event of a payment delay of more than two weeks, all other claims of Perpedes GmbH are due for immediate payment. In the case of late payment, interest on late payment will be charged at 5 percentage points above the base rate. Without this depriving the Contract Partner of their right to show that smaller damage occurred, statutory interest on arrears is calculated in accordance with sec. 288(2) of the BGB as a minimum. In principle and not later than after sending the second reminder, we commission a collection office which causes additional costs for the Contract Partner. Prior to the complete payment of all due invoices, including interest on arrears and reminder costs, Perpedes GmbH is not obliged to make further deliveries from any existing orders.

## 11. SEPA BANK COLLECTION PROCEDURE

In the case of a SEPA core direct debit mandate, the invoice amount is collected by direct debit within 10 days from the invoice date with a cash discount of 3 % on all amounts eligible for discounts. The pre-notification will be delivered 3 days before collection for German contract partners and 6 days before the collection for international ones. The Contract Partner agrees to shorter pre-notification periods and shorter periods for the notification of collection indicated on the payment advice. The Contract Partner undertakes to ensure that the account has sufficient funds. Costs incurred as a result of direct debit non-redemption or chargebacks shall be borne by the Contract Partner, unless such non-redemption or chargeback was caused by Perpedes GmbH.

## 12. RESERVATION OF TITLE

The delivered goods remain the property of Perpedes GmbH until all claims were fulfilled. The goods must not be pledged or transferred by way of security until payment was made. Attachment by third parties shall be immediately reported to us. In the event of a resale to third parties, the claim arising from the resale amounting to the outstanding selling price is assigned to Perpedes GmbH right from the beginning. In the case of processing or mixing, loss of rights according to sec. 951 of the BGB shall be compensated. As early as at the time of contract conclusion, the Contract Partner assigns to Perpedes GmbH the claim to the new item – if necessary a partial claim in the processed item. If we assert a right of retention of title, this must not be deemed a withdrawal from the contract. The Contract Partner shall bear the costs of interventions and acceptance of returned goods. In other countries, the Contract Partner shall respect Perpedes GmbH's rights to retain title. The Contract Partner bears all costs we incur as a result of repossessing the goods subject to retention of title. If we assert our claim for surrender, we are entitled – without regard to the Contract Partner's obligation to pay – to exploit the delivered item which we took back into possession, together with all accessories, in the best possible way by means of direct sale.

## 13. WARRANTY

Complaints must be notified in writing immediately after receiving the shipment. Upon receipt, the shipping goods must be checked for completeness and visible damage or defects. Our warranty obligation lapses in particular if the delivered item was modified by third parties or used in combinations with foreign parts not authorised by us and if the damage is connected to this. In the event of a substantiated complaint, replacement deliveries or refunds will be made at our discretion. Any further liability for defects or any claims for damages remain excluded.

#### 14. SHOE/GOODS RETURNS

The returning of shoes generally requires our prior consent. In this regard, the Contract Partner shall provide us with evidence of having received the goods, with it being sufficient to provide the invoice number and date in the form of an invoice copy. In order to be able to refund the Contract Partner for the return of items, the items are to be returned in a saleable original state (unworn; undamaged; untainted; and unprocessed) and with the individual shoe labels (model; size; batch). A return on goodwill within 3 months after the invoice date can no longer be accepted for refunds and/or exchange.

Goods can only be returned outside any warranty rights if this was expressly agreed beforehand. The return takes place only against a credit note taking into account devaluations due to the age and the condition of the items at the time of return and a processing discount of 10 % of the agreed price of the goods. The costs for the return shall be borne by the Contract Partner. For customised and special products, especially for configured inlay blanks, return is excluded in any case. This includes in particular combinations (mixtures/compounds) of standard articles.

#### 15. VIOLATION OF PROTECTION RIGHTS

We work carefully when recording and processing orders in order to prevent a violation of third-party protection rights (patents, design rights, utility model rights and other property rights). We are not liable for any violations of intellectual property rights which our contract and/or toll manufacturers commit. The Contract Partner is responsible for requesting the order to be performed in such a way that rights of third parties are not violated.

#### 16. RIGHT TO EXCLUSIVE DISTRIBUTION

To acquire exclusive distribution rights in our products, a written approval by the management is generally required.

#### 17. EXCLUSION OF LIABILITY

We are liable without limitations in the event of culpable injuries to life, limb and health. Apart from that, our liability is limited to foreseeable damage typical of the contract; further liability – irrespective of the legal reason – is excluded, unless otherwise stipulated in these Terms.

#### 18. DATA PROTECTION

The Contract Partner agrees to personal data collection, processing and use if this relates to the placing, contents structure or modification of the orders in accordance with the General Data Protection Regulation (GDPR) and other data protection regulations. In particular, they consent to the processing or execution of their order in accordance with Art. 7 and Art. 8 of the GDPR. Your data will be treated confidentially and not be passed on to third parties. For the complete processing of your order, we cooperate with service providers to whom we transmit certain data (family name; first name; street) for order fulfilment. This includes our service providers for the delivery of orders. Likewise, this data is passed on to third parties to process payments in the context of invoice processing. All our service providers are obliged to use the data only for the above purpose and may not pass it on to third parties.

#### 19. FINAL PROVISIONS; PLACE OF PERFORMANCE; VENUE

Should a provision of these Terms be or become ineffective in whole or in part, the other provisions remain unaffected by this. The Parties hereby agree, right from the beginning, upon a legally effective regulation coming closest to the economic purpose of the invalid provision. Ancillary agreements are void if not expressly confirmed by Perpedes GmbH in writing. All legal relationships are subject to German civil and commercial law, excluding the CISG regulations. The place of performance and venue is Kirchheim/Teck for both Parties. However, we are also entitled to bring an action at the Contract Partner's registered office.

Lenningen, April 2021

#### PROVISIONS RELATING TO REGULATION (EU) NO. 2017/745 ON MEDICAL DEVICES

as a supplement to sec. 3 of the regulations on medical devices under our General Terms and Conditions. By concluding a contract with the Contract Partner, the duties and responsibilities between Perpedes GmbH and the Contract Partner as the dealer in terms of the MDR are regulated as follows:

##### 1. ROLE OF PERPEDES GMBH AS THE SUPPLIER AND THAT OF THE CONTRACT PARTNER AS THE CUSTOMER

Within the scope of these terms of supply and with regard to the medical devices, the supplier has the position of a manufacturer in accordance with Art. 2 no. 30 of Regulation (EU) no. 2017/745, and the Contract Partner has that of a dealer in accordance with Art. 2 no. 34 of Regulation (EU) no. 2017/745.

##### 2. OBLIGATIONS FOR DEALERS

The customer undertakes to comply with the obligations for dealers applicable to them as a dealer in accordance with Art. 14 of Regulation (EU) no. 2017/745.

##### 3. TRACEABILITY

The customer and the supplier work together to ensure traceability of the goods. In accordance with Article 25(2) of Regulation (EU) no. 2017/745, the customer undertakes to ensure that, for a period of ten years after delivering the last items, they are able to inform the competent authority at any time about the companies from/to which they received/sold the items. In this respect, the customer undertakes to set up a procedure suitable for this information exchange and to document the procedure in accordance with point 7.5.9 of ISO 13485:2016. The purchaser undertakes to hand over the documentation suitable for the provision of information to the supplier after the expiry of the above ten-year period or to professionally dispose of it upon the supplier's written request. The purchaser undertakes to comply with the obligations under para. 3, even if they discontinued their operations prior to the ten-year period terminating or if insolvency proceedings are instituted against them.

##### 4. ACCEPTING AND DOCUMENTING EXPERIENCES, FINDINGS AND OTHER INFORMATION ABOUT THE GOODS

The customer undertakes to document all experiences and findings about the items, including trends to be observed, and all complaints or reports they receive about alleged events in connection with the items and to keep this documentation for a period of ten years. To this extent, the customer undertakes to implement appropriate procedures for receiving and storing such experiences, findings, complaints or reports on the items and for their documentation and to keep this documentation up to date. The customer undertakes to hand over to the supplier the documentation about experiences and findings concerning the items, including trends to be observed, and all complaints or reports they received after the above ten-year period expired or to professionally dispose of them after the supplier's written request. The purchaser undertakes to comply with the obligations under para. 4, even if they discontinued their operations prior to the ten-year period terminating or if insolvency proceedings are instituted against them.

##### 5. TRANSFER OF EXPERIENCES, KNOWLEDGE AND OTHER INFORMATION TO THE SUPPLIER

The customer undertakes to immediately forward to the supplier or to any other bodies commissioned by the supplier all experiences and findings about the items, including trends to be observed, and all complaints or reports they receive about alleged events in connection with the items. This shall be forwarded in writing to [Perpedes GmbH, Härtwasen 8-14, 73252 Lenningen]. In the case of suspected serious incidents pursuant to Art. 2 no. 64 of Regulation (EU) no. 2017/745, forwarding is to be effected in advance by means of telephone (+49 (0)7021 738 30-0), fax (+49 (0)7021 73830-298) or e-mail (info@perpedes.de).

##### 6. ADVERTISING

The supplier makes available to the customer all materials for advertising the goods (e.g. texts, descriptions, trademarks, pictures and other signs), provided that the customer advertises the goods. The customer undertakes to use the materials provided by the supplier only when advertising the goods.



[WWW.PERPEDES.COM](http://WWW.PERPEDES.COM)

Order and Support:  
Mon. - Thu: 8.00 am - 4.00 pm  
Fri. 8.00 am - 3.00 pm  
T. +49 (0) 7021 738 30 - 0  
F. +49 (0) 7021 738 30 - 298  
[info@perpedes.com](mailto:info@perpedes.com)

Return address:  
Perpedes GmbH  
Tannenbergr. 139  
73230 Kirchheim unter Teck  
Germany